

Summer 2014

# An analysis of burn cut pull optimization through varying relief hole depths

Michael Robert Allen

Follow this and additional works at: [http://scholarsmine.mst.edu/masters\\_theses](http://scholarsmine.mst.edu/masters_theses)



Part of the [Mining Engineering Commons](#)

**Department:**

## Recommended Citation

Allen, Michael Robert, "An analysis of burn cut pull optimization through varying relief hole depths" (2014). *Masters Theses*. 7296.  
[http://scholarsmine.mst.edu/masters\\_theses/7296](http://scholarsmine.mst.edu/masters_theses/7296)

This Thesis - Open Access is brought to you for free and open access by Scholars' Mine. It has been accepted for inclusion in Masters Theses by an authorized administrator of Scholars' Mine. This work is protected by U. S. Copyright Law. Unauthorized use including reproduction for redistribution requires the permission of the copyright holder. For more information, please contact [scholarsmine@mst.edu](mailto:scholarsmine@mst.edu).



AN ANALYSIS OF BURN CUT PULL OPTIMIZATION THROUGH VARYING  
RELIEF HOLE DEPTHS

by

MICHAEL ROBERT ALLEN

A THESIS

Presented to the Faculty of the Graduate School of the  
MISSOURI UNIVERSITY OF SCIENCE AND TECHNOLOGY

In Partial Fulfillment of the Requirements for the Degree

MASTER OF SCIENCE IN EXPLOSIVES ENGINEERING

2014

Approved by

Paul Worsey, Advisor  
Gillian Worsey  
Jason Baird



## ABSTRACT

In underground blasting, the pull of the initial cut is the limiting factor for the success of the rest of the round. By improving the pull of the first cut, a critical step is made towards improving the entire round. This project attempted to optimize a burn cut's effective pull by varying the depths of the relief holes in the burn, and then analyzing the results. In testing, relief holes were drilled to depths both shorter and longer than that of the cut's charged holes. The overall objective was to consistently achieve greater pull than in a standard burn, using an identical amount of explosives. Increased pull results in savings of both time and cost in underground heading advance.

The testing was conducted in dolomitic limestone at the Missouri S&T Experimental Mine. The project utilized a small diameter hole burn design that has historically proven to be successful in the rock type in which the tests were being completed. Burn cuts were drilled and shot separate of the full standard round. This allowed for the author to analyze depth of pull solely in respect to the initial cut holes. Drilled with a jackleg and a design template, identical replications of the cut were tested and pull measurements were obtained.

With all testing completed and results analyzed, the data suggests that a depth of pull greater than the length of the longest charged hole can be achieved through the application of lengthened relief holes. The tests consistently show an average pull increase of 3 inches, which results in an average pull of 105 percent in the rounds. The findings produced by this project should prove beneficial for work performed in similar blasting conditions as well as in various rock types and other burn configurations.

## ACKNOWLEDGEMENTS

I would like to thank Dr. Paul Worsley for his guidance and help throughout this project. I would also like to thank Jimmie Taylor, Dewayne Phelps, David Phelps, and Kevin Phelps for their assistance in the completion of the testing process. Without their help, this project would have been impossible to complete. Additionally, I would like to thank John Tyler for his time and skills used in crafting the drilling template utilized in this project. Furthermore, I would like to thank Dr. Gillian Worsley and Dr. Jason Baird for their knowledge, assistance, and advice in completing this work.

Also, I would like to thank the explosives companies that donated the product used throughout this project. Without the generosity of companies like Dyno Nobel and Orica, this research as well as many other projects could not be completed at the Experimental Mine.

Finally, I would like to thank my parents who have made everything leading up to this point possible. Their assistance and support in completing all my education endeavors has been essential to my success. I would not have reached the position I am at, if it was not for them.

## TABLE OF CONTENTS

	Page
ABSTRACT.....	iii
ACKNOWLEDGEMENTS.....	iv
LIST OF ILLUSTRATIONS.....	ix
LIST OF TABLES.....	xi
DEFINITIONS.....	xii
<b>SECTION</b>	
1. INTRODUCTION.....	1
1.1. PURPOSE OF BURN CUT OPTIMIZATION.....	1
1.2. IMPORTANCE OF THE OPTIMIZATION PROJECT.....	1
1.2.1. Project Scope .....	2
1.2.2. Rock Type Differences .....	2
1.2.3. Burn Cut Design Patterns.....	2
1.3. REASON FOR PROJECT SELECTION.....	3
2. BACKGROUND.....	4
2.1. OPENING CUTS .....	4
2.1.1. Selecting the Cut.....	4
2.1.2. Effect of Rock Conditions .....	5
2.2. RELEVANT LITERATURE .....	6
2.2.1. Increased Relief Hole Length .....	6
2.2.2. Drilling Accuracy.....	9
2.2.3. Burn Cut Pull .....	10
2.3. PROJECT'S RELEVANCE.....	12
3. EXPERIMENTAL METHOD .....	13
3.1. TESTING LOCATION .....	13

3.2. BURN CUT DESIGN .....	15
3.2.1. Pattern Selection .....	15
3.2.2. Burn Cut Design .....	16
3.2.3. Burn Cut Design Depth.....	18
3.3. DRILLING .....	20
3.3.1. Drilling Equipment .....	20
3.3.2. Drilling and Mounting the Template .....	23
3.3.3. Drilling the Burn Cut Pattern.....	25
3.4. LOADING THE ROUND .....	27
3.4.1. Explosive Product .....	27
3.4.2. Loading Procedure .....	28
3.4.3. Round Timing .....	29
3.4.4. Firing Procedure.....	31
3.5. DATA COLLECTION .....	31
3.5.1. Mucking out the Cut .....	31
3.5.2. Photographing the Cut .....	32
3.5.3. Measuring Bootleg and Pull.....	32
3.5.4. Profiling the Back of the Cut .....	34
4. RESULTS.....	36
4.1. BASELINE TESTS .....	36
4.2. SHORTENED RELIEF HOLE TESTS .....	37
4.2.1. Burn Cuts with 4 Foot Relief Holes.....	37
4.2.2. Burn Cuts with 4.5 Foot Relief Holes.....	40
4.2.3. Delay Timing Variations.....	41
4.3. EXTENDED RELIEF HOLE TESTS .....	44



4.3.1. Burn Cuts with 6 Foot Relief Holes.....	44
4.3.2. Burn Cuts with 5.5 Foot Relief Holes.....	45
4.3.3. Delay Timing Variations.....	47
4.3.4. Reverse Priming Results.....	49
4.4. RESULTS SYNOPSIS.....	50
5. DISCUSSION.....	51
5.1. BASELINE TESTS.....	52
5.2. SHORTENED RELIEF HOLE TESTS.....	53
5.2.1. Burn Cuts with 4 Foot Relief Holes.....	53
5.2.2. Burn Cuts with 4.5 Foot Relief Holes.....	54
5.2.3. Shortened Relief Hole Breakage Analysis.....	55
5.3. EXTENDED RELIEF HOLE TESTS.....	55
5.3.1. Burn Cuts with 6 Foot Relief Holes.....	55
5.3.2. Burn Cuts with 5.5 Foot Relief Holes.....	57
5.4. ANGLE OF BREAKAGE.....	59
5.5. DELAY TIMING VARIATION.....	64
5.6. REVERSE PRIMING.....	66
6. CONCLUSIONS.....	67
7. FURTHER WORK.....	71
APPENDICES	
A. DRILLING TEMPLATE AND SPLIT COLLET DESIGNS.....	74
B. EXPLOSIVES TECHNICAL DATA SHEETS.....	78
C. PHOTOGRAPHS OF BOOTLEG MEASURING DEVICE.....	86
D. 4 FOOT - SHORTENED RELIEF ROUND DATA.....	88
E. 4.5 FOOT - SHORTENED RELIEF ROUND DATA.....	90

F. 6 FOOT - EXTENDED RELIEF ROUND DATA.....	92
G. 5.5 FOOT - EXTENDED RELIEF ROUND DATA.....	94
BIBLIOGRAPHY.....	96
VITA.....	98

## LIST OF ILLUSTRATIONS

	Page
Figure 3.1. Mine Map and the Photo of Testing Area .....	14
Figure 3.2. Clay and Pyrite Zone .....	14
Figure 3.3. Cat-Hole Cut - Hole Layout .....	16
Figure 3.4. Design Calculations Illustration .....	17
Figure 3.5. Burn Cut Design Schematic .....	18
Figure 3.6. 1 <sup>5</sup> / <sub>8</sub> inch Cross Bit and Steel.....	20
Figure 3.7. Burn Cut Drilling Template.....	21
Figure 3.8. Split Collet.....	22
Figure 3.9. An Example <sup>1</sup> / <sub>2</sub> - 13 Ready Rod and Korker .....	23
Figure 3.10. Mounted Drilling Template .....	24
Figure 3.11. Inserting the Split Collet and Leveling the Steel.....	25
Figure 3.12. Reference Holes.....	27
Figure 3.13. The Two Priming Methods.....	29
Figure 3.14. Typical Delay Times on Rounds .....	30
Figure 3.15. Measuring Pole in Use.....	33
Figure 3.16. Profile Sketch Example .....	35
Figure 4.1. Typical Baseline Relief Hole Round .....	37
Figure 4.2. Shortened Relief Hole Cut Regions Diagram .....	38
Figure 4.3. Pull Results - 4 Foot Relief Hole Burn Cuts .....	39
Figure 4.4. Pull Results - 4.5 Foot Relief Hole Burn Cuts .....	40
Figure 4.5. Typical Shortened Relief Hole Round .....	42
Figure 4.6. Average Pull per Burn Cut Delay Region .....	43
Figure 4.7. Pull Results - 6 Foot Relief Hole Burn Cuts .....	44
Figure 4.8. Pull Results - 5.5 Foot Relief Hole Burn Cuts .....	46
Figure 4.9. Typical Extended Relief Round .....	48
Figure 4.10. Extended Relief Hole Cut Regions Diagram.....	48
Figure 5.1. Average Pull Summary.....	51
Figure 5.2. Round Advance by Relief Hole Depth and Diameter .....	52
Figure 5.3. Extended Breakage Angle Diagram .....	59

Figure 5.4. Breakage Angle Diagram .....	62
Figure 5.5. Breakage Angles - All Test Variations.....	63
Figure 5.6. Breakage Zone Diagram.....	65

## LIST OF TABLES

	Page
Table 3.1. Number of Test Rounds Conducted at Each Relief Hole Depth .....	19
Table 4.1. Pull Percentages for 4 Foot Relief Hole Tests .....	39
Table 4.2. Pull Percentages for 4.5 Foot Relief Hole Tests .....	41
Table 4.3. Pull Averages in each Burn Cut Region – Grouped by Delay Time .....	42
Table 4.4. Pull Averages for 6 Foot Relief Hole Tests .....	45
Table 4.5. Pull Averages for 5.5 Foot Relief Hole Tests .....	46
Table 4.6. Extended Pull Averages in each Burn Cut Region .....	49
Table 4.7. Reversed Prime Pull Averages .....	50
Table 5.1. Burn Cuts with 4 Foot Relief Holes Summary .....	53
Table 5.2. Burn Cuts with 4.5 Foot Relief Holes Summary .....	54
Table 5.3. Burn Cuts with 6 Foot Relief Holes Summary .....	56
Table 5.4. Possible Production Increases with Example Heading Sizes .....	57
Table 5.5. Burn Cuts with 5.5 Foot Relief Holes Summary .....	58
Table 5.6. Breakage Angles – Extended Pull Burn Cuts .....	60
Table 5.7. Hypothetical Extended Pull Results with Larger Hole Diameter .....	61
Table 5.8. Breakage Angles – Reduced Pull Burn Cuts .....	63

## DEFINITIONS

**Charged Hole** – A borehole primed and loaded with explosive.

**Relief** – The distance to the nearest free face or the reduction of confinement provided by a free face or the addition of empty boreholes.

**Relief Hole** – A borehole drilled in a burn cut that is intentionally left empty in order to provide additional relief for a charged hole.

**Burden** – The distance from a loaded borehole to the nearest free face or relief hole.

**Primer** – A cartridge of explosive used to initiate other explosive product, when combined with a detonator or other form of initiator.

**Face** – A vertical rock surface in an underground mining operation.

**Burn Cut** – A type of opening cut blast design that utilizes one or more empty relief holes to give relief to the round's charged holes.

**Pull** – The depth to which an underground round breaks; measured in comparison to the length of the loaded boreholes in the round.

**Bootleg** – The part of a borehole that is left behind when the loaded explosive does not fully break the rock to the back of the hole.

**Reverse Priming** – The method of priming a blast hole by placing the primer near the collar of the hole, rather than at the back of the round as typically would be done. The cartridge is positioned with the cap pointing at the back of the blast hole. Sometimes this method is referred to as direct priming.

## **1. INTRODUCTION**

The first issue the author discusses is the purpose of this research project and the problem being addressed. Next, this section outlines the importance of the work done and the significance it holds for the blasting industry as a whole. Finally, the author explains how the benefits of this work could reach beyond the specific blasting technique being analyzed and why this project was selected.

### **1.1. PURPOSE OF BURN CUT OPTIMIZATION**

In underground blasting, the opening cut in a heading round is essential to the success of the entire round. In order for the heading to pull to its designed and drilled depth, the opening cut must provide relief to that depth. The burn cut is a blasting method that is often used throughout industry to provide the relief that the rest of the heading requires to break effectively. Typically, all holes, charged and relief, in a burn cut will be drilled to a uniform depth, the same as the rest of the round. The purpose of this burn cut optimization project is to determine whether it is possible to obtain a pull deeper than what is achievable through the standard uniform hole length method. By varying the length of relief holes in burn cut rounds while holding the charged holes constant in both depth and explosive loading, the author can analyze the pull results and determine if greater pull depths are achievable.

### **1.2. IMPORTANCE OF THE OPTIMIZATION PROJECT**

In modern underground mining, bootleg is still a very common occurrence and can even be habitual enough to become a serious problem. When bootleg is left in the face of an underground heading, the cost is twofold. Not only is the operation not achieving the designed and desired production, but it is also wasting time and money drilling and loading explosive into rock that will not be broken. The rock surrounding a bootleg will not be excavated until the succeeding shot, effectively costing the operator

twice the amount of time and money to drill and load this material. The elimination of bootleg is essential to the optimization of a mine's blasting and thus production.

The goal of this project is to optimize the pull of the burn cut in order to create greater relief for the rest of the underground heading round. The increase in relief will help to reduce the bootleg left by heading blasts. Although it is unlikely that burn cut optimization alone will completely eliminate bootleg, it is a step towards minimizing it and increasing efficiency.

**1.2.1. Project Scope.** Although the burn cut optimization is being done at the Missouri S&T Experimental Mine, it is not just the University's educational facilities that will benefit from the results. Research findings that show greater pull is achievable using the same drilling pattern and identical amount of explosive, could prove beneficial to any underground mining or tunneling operation that utilizes burn cuts in their blasting. In an industry where reducing costs per ton or per cubic yard is the highest financial consideration, moving more rock with the same amount of explosives is worth investigation.

**1.2.2. Rock Type Differences.** The rock being tested in this project is dolomitic limestone. Although the rock most mining and tunneling operations work in may not have the identical properties as the test rock in this project, it is likely that comparable results would be obtainable in locations with similar rock types. Specifically, this author would expect other types of limestone to react in a similar manner to the burn cut modifications made in the testing process. There is also a high likelihood that the concepts and practices employed for this project may also work in other rock types with properties differing greatly from dolomitic limestone, possibly providing even better results when varying the length of the relief holes in the burn cut rounds.

**1.2.3. Burn Cut Design Patterns.** There are multitudes of burn cut designs that have been tested and utilized in underground blasting since the method was first devised. Different designs have proven to be more suitable for various applications and less suitable for others. Although this project examines only one burn design in particular, the conclusions drawn from its results could bridge the gap between various designs. The design concept adaptations utilized throughout this project could easily be made to any other burn cut round. There is no specific design characteristic contained in the burn cut



pattern tested in this project that makes it better suited for extended round pull through varying the relief borehole length. In fact, it may be found, through experimentation, that other burn cut designs prove more likely to achieving an advance in pull.

### **1.3. REASON FOR PROJECT SELECTION**

This author selected this project for several reasons. With the equipment and resources available at the Experimental Mine, the project was feasible without incurring high costs or additional investments and could provide results directly affecting the rock blasting industry. This was important to the author, desiring to make meaningful conclusions that could have a wide impact on underground blasting, while maintaining a scope which was readily accomplishable. Realizing an increase in pull from the burn cut, while keeping explosives' costs constant, would be highly significant and could be applied to any underground operation utilizing burn cuts for their heading advances. If the project's goals are achieved, and the blasting industry adopts extended relief hole design practices, the cost saving benefit could be significant when considering the industry as a whole. Also, even though the project is conducted in dolomitic limestone, the extended relief designs could possibly be adapted to other types of underground operations. The project also identifies other areas of the burn cut and heading rounds that would benefit from optimization work. Work in these areas would also be advantageous to the underground blasting industry as a whole. Furthermore, optimization has become a very important topic in the mining and blasting industry, so this project provides real world experience to the author that will be useful in the future.

## 2. BACKGROUND

The initial background information, reviewed by this author in conjunction with this project, covered the application and significance of the burn cut in underground mining. This review then delves into previous work that has been done in the field to improve the burn cut round. This includes work done by industry professionals and university researchers.

### 2.1. OPENING CUTS

The opening cut is the most critical part of any underground blast design [1]. Employed in underground blasting situations where only a single free face is available to blast to, the cut is intended to pull all the way to the back of the round and eject the fragmented material clear of the rock mass. This creates a second, more suitably oriented, free face for the remainder of the round. The cut must provide the relief necessary for the rest of the round to break effectively. Failure to provide this relief results in poor performance of the entire blast.

**2.1.1. Selecting the Cut.** In underground mining, there are two types of opening cuts that can be used to provide the relief required for a successful round. The two types are angled and burn (or parallel) cuts. The first utilizes angled holes to provide the relief for the rest of the round. Some of the common angle cut designs include the V, the pyramid, and the fan. These rounds are typically used in underground excavation where there is a large cross sectional area [1]. Due to the angle at which the drill must align on the face for drilling these rounds, a narrow heading is not generally conducive to their application. These rounds are also limited in the advance they can make due to the geometry of the pattern. The second type of cut relies on the use of holes drilled straight into the rock face, each in parallel. This attribute makes it perfectly suited for application in underground headings with a small cross sectional area. An extensive list of burn cut designs has been tested and utilized in the blasting industry for many years. A burn cut is selected for use generally, because it has previously been known to work in similar rock

conditions, through trial and error, or through a combination of the two. In either situation, once the blasting operation finds a specific design that works for their needs, it is typically there to stay.

*The Modern Technique of Rock Blasting* by Langefors and Kihlström gives a broad overview of the more common types of parallel cut designs [2]. One of the burn cut patterns they analyze is the cat-hole cut (see in Figure 3.3), which is the style of burn utilized throughout this project's testing. The authors note the round is an adaptation of the Grönlund cut and has the advantage of employing a single hole diameter across the round, thus requiring no additional equipment besides the drill. This makes it ideal for application in narrow heading blasting employing only small drills, such as the Missouri S&T's jackleg operation. It is also advised in the book, to reverse prime the first hole of the Grönlund cut by applying the primer containing a 0 millisecond delay close to the rock face, rather than at the back of the hole. The authors imply this will improve the performance of the round. Due to the similarities between the Grönlund and the cat-hole, reverse priming may also prove effective on the latter cut as well. One final benefit shared by the cat-hole design and similar type designs is the utilization of empty holes between each of the charged holes in the center of the cut [3]. This pattern geometry greatly reduces the chance of sympathetic detonation or dead pressing, either of which will cause the cut to fail.

**2.1.2. Effect of Rock Conditions.** Experts in the area of blast design often stress the influence different rock types and rock conditions can have on the success of a burn cut. Bullock notes that a dramatic difference can be observed when blasting in brittle rock, such as granite, versus a spongy (plastic) rock, such as soft limestone [3]. He adds that burn cuts utilized in spongier rock types require a slower explosive than the more brittle rock types. If the blaster does not account for this difference, the round is likely to freeze up. Bullock concludes that spongy rock will undergo plastic deformation, rather than breakage, if an explosive with too high of a detonation velocity is employed. Heeding Bullock's advice as well as the observations made by previous researchers working in the rock used in this project, this author knows these conditions may play a factor in this optimization project's testing and thus must be accounted for in experimental design [4]. One of the ways in which this will be done, is through the

application of a pattern with multiple relief holes, rather than a single large diameter hole. This practice is suggested by Sharma in his paper, “Tunnel Blasting – Emulsion Explosives and Proper Blast Design are the Prerequisite for Better Efficiency”, in order to prevent freezing in spongy rock types [5].

Langefors and Kihlström cover several controlling factors put in place on the cut by the rock being blasted [2]. In their work, they observed how breakage conditions are dependent on the structure of the rock. They note how the cavity created by the cut, particularly in the firing of the opening hole of the round, can vary greatly between rounds. Because of this, the cut must be designed to allow for these variations. These authors also emphasize the effect the rock quality can have on the overall pull of the round. They found that crevices and clay seams increased the chances of sympathetic detonation as well as affecting drilling accuracy, both of which can cause the round to perform poorly. Furthermore, Langefors and Kihlström advise when starting blasting in a new rock body to begin drilling at depths 50 to 70 percent of what would normally be acceptable. With successful advances at the reduced depths, the rounds can be gradually increased until the maximum depth the rock conditions permit is reached.

## 2.2. RELEVANT LITERATURE

There is a substantial amount of research that has been completed on burn cuts. Because of this, literature must be selected on its level of significance to this optimization project. The areas reviewed in this section relate directly to the testing done on varied relief hole length burn cuts.

**2.2.1. Increased Relief Hole Length.** This author encountered little previous research that discussed the possible benefits of increasing the length of a burn cut’s empty relief holes. Although several of the documents found clearly identified that burn cuts were more likely to perform successfully with this hole depth change, only one researcher considered the possibility of breakage extending past the backs of the cut’s charged holes.

One of the documents reviewed which specifically noted the benefits of drilling the burn cut round’s relief holes deeper than the pattern’s charged holes is titled

“Suggestions for Successful Blasting” by Singh [6]. The paper covers a broad spectrum of areas and factors of the burn cut that could be manipulated, in order to increase the chances of the cut pulling successfully. Singh tested multiple burn designs, varying factors throughout the process, in order to determine which factors lead to a successful cut. The document concludes that drilling the relief holes in a burn slightly deeper than the designed pull depth of the cut is an important feature to achieve success. Singh indicates this adaptation’s link to success is comparable to that of hole spacing, sufficient relief area, and drilling accuracy. Additionally, Singh stresses the importance of limiting drilling deviation, and how the negative effects of drilling inaccuracy multiply the deeper a round is drilled. It must be noted, that the document does not quantify the added success of using deeper relief holes nor whether any of the rounds tested pulled deeper than their charged hole depth. The testing completed for this project takes Singh’s work one step further, by working to obtain an increased pull beyond the charged hole depth and quantifying that additional breakage.

Another paper titled “Innovative Blasting Techniques for Excavation of Long Tunnel Rounds” suggests the utilization of lengthened relief holes has advantageous effects on the pull of the burn cut [7]. The paper details the driving of a small diameter tunnel through granite for the use of the Underground Research Laboratory of the Atomic Energy of Canada Ltd. The tunnel provided the research team the opportunity to make novel changes to their normal burn cut pattern and blasting practices, while attempting to minimize blast induced overbreak in the tunnel walls. Their goal of minimizing overbreak was determined critically dependent on the successful pull of each round’s opening cut. If the burn did not pull cleanly, the burden on the standard round’s holes would be increased past the distance to which they were designed. This increase in burden would transfer across the round causing over confinement on the perimeter holes. Over confinement is known to cause excessive overbreak to the final walls [1]. Throughout the tunneling process, each round utilized three 89 or 100 millimeter (3.5 or 3.9 inch) diameter relief holes and typically sixty-five 38 millimeter (1.5 inch) charged holes. Among other design innovative practices used in the tunneling rounds, each round’s relief hole was drilled 300 millimeters (11.8 inches) deeper than the round’s charged holes. The paper notes that the research team anticipated the added length would

improve the chances of the backs of the charged holes breaking cleanly to the relief holes. In testing, they observed no bootlegs in the middle of their rounds, indicating a 100 percent pull. The study states that the average advance achieved matched the depth of the charged boreholes, but makes no note of an extended pull in the burn cut region of the round. The burn cuts did provide the relief required for the rest of the round to pull effectively, assisting in the prevention of overbreak in the tunnel walls.

Similarly, a burn cut of the same design was employed for the sinking of the shafts during the same underground construction project [8]. In this application, the rounds were much shorter in length, varying between 1 and 3.5 meters (3.3 and 11.5 feet). The relief holes were again drilled an additional 300 millimeters (11.8 inches) deeper than the charged holes, while maintaining the same layout and hole diameter. Due to the vertical nature of these rounds, results were expected to vary in comparison to the horizontal tunneling applications. In this application of the extended relief hole burn cut, the shaft sinking rounds averaged from 89 to 94 percent pull, with the highest percentage advances being delivered from the longest rounds. There is no data given on the success of the round without the inclusion of extended relief holes, but the research team states that the addition improved the ability of the cut's charged holes to break cleanly to the relief holes.

Another pertinent paper, written by Hagan, mentions the importance of drilling relief holes longer than the charged holes in the round. In his paper "Larger Diameter Blastholes – A Proposed Means of Increasing Advanced Rates", Hagan states an extended depth of 300 millimeters (11.8 inches) on a 115 millimeter (4.5 inch) diameter relief hole will allow "the toe of each charged hole to crater to a .3m long void beyond the plane containing the bottoms of the blastholes" [9]. In a subsequent paper "Means of Increasing Advance and Reducing Overall Costs in Drill-and-Blast Tunneling", Hagan provides a slightly lower suggested depth increase of 200 to 250 millimeters (7.9 to 9.8 inches), again stating that the toe of the charged hole will have a larger free face in which to break towards [10]. In this instance, Hagan provides no specific hole diameter, but again makes references to large diameter hole burn cut patterns. In both cases, Hagan indicates, like all the other researchers who discussed extended relief hole length, that the

application of an increased relief hole length will aid in obtaining a more complete pull from the burn and consequently help to minimize bootleg in the cut.

**2.2.2. Drilling Accuracy.** Almost all literature written on burn cut blasting places drilling accuracy as the most critical factor for the success of the round. Borehole deviation will cause even a perfectly designed round to fail. Without accurate drilling a number of issues can occur in the pattern. These issues include borehole intersections, increased burden, and decreased burden, all of which can result in dead pressing or sympathetic detonation, depending on the explosive being used. In comparison to the rest of the heading drill pattern, the burn is also much more sensitive to deviation due to the tight spacing placed between holes.

A review of work completed on drilling accuracy in underground heading applications was conducted. There are a number of works discussing the topic and providing similar information, so this author will provide an overview of the relevant findings. One of the main ways of preventing deviation is to understand where it comes from and its causes. Langefors and Kihlström [2] provide an equation for calculating the deviation of a borehole, where deviation comes from three places: error in collaring ( $R_c$ ), error in alignment ( $R_d$ ), and drilling deviation inside the rock ( $R_r$ ).

$$R = (R_c^2 + R_d^2 + R_r^2)^{1/2} \quad (1)$$

This equation illustrates the three locations where inaccuracy occurs. The first two areas are controlled by how the driller sets up on the rock face. If the driller collars the borehole in a location out of position with the design, deviation is unavoidable. The authors go on to explain that as long as collaring occurs within 2 centimeters of the designed hole location, the error has a minute impact on the hole's overall deviation. Similar to the deviation caused by collaring placement errors, alignment error is caused by the angle at which the driller lines up on the face. If not at the intended angle, both vertically and horizontally, the hole continues to deviate at that angle as the hole progresses. On modern equipment, this error is easier to prevent due to automated technology utilized onboard, such as inclinometers, but on older equipment and hand held drills, like the jackleg, the error is harder to prevent. Langefors and Kihlström also

outline the main forms and causes of deviation while drilling inside the rock. These include upwards and downwards hole deviation caused by the weight of the bit and weight of the steel, respectively. The weight of either can cause the steel to flex and the hole's path to curve. Additionally, geological factors, such as planes, variable rock strengths, and weak seams, as well as the application of too much down pressure through the drill feed can result in an undesirable change in the direction of bit penetration [11]. The literature review recommends the application of larger diameter and more rigid drill steels as well as the utilization of well trained, experienced drillers to help to prevent these causes of deviation. A value of 4 percent is provided as an acceptable borehole deviation (presented as a percentage of hole depth) for underground heading drilling, while 1 percent is considered "very careful drilling" [12].

The knowledge gained from these previous works has been applied to this optimization project. With such stress placed on the importance of limiting borehole deviation in burn cut rounds, tests were designed to avoid drilling error as much as possible. Because of the imprecise nature of jackleg drilling, in comparison to modern drill rigs, a drilling template was crafted to assure holes are as accurate to the design as possible. The template utilized is very similar to templates once used by jackleg drillers in underground mines. Furthermore, for this project the author used an additional split collet type device to ensure even greater precision. The device locks the drill steel in place, so that the hole is collared precisely in the intended location and at the correct alignment on the face. The split collet will be discussed further in a later section.

**2.2.3. Burn Cut Pull.** Several documents were reviewed in relation to the pull of burn cut rounds. The first resource reviewed on this topic was Persson, Holmberg, and Lee's book, *Rock Blasting and Explosives Engineering* [13]. The authors present valuable information on the design of a burn cut round. The book provides an equation for determining the maximum recommended hole depth (H) and advance (I). Equation 2 and Equation 3 utilizes the relief hole diameter ( $\emptyset$ ) to estimate those values, respectively.

$$H = 0.15 + 34.1\emptyset - 39.4\emptyset^2 \quad (2)$$

$$I = 0.95H \quad (3)$$



The authors state these equations only remain valid if the drilling deviation does not exceed 2 percent. This means that if deviation becomes greater than 2 percent, the advance will no longer be estimated at 95 percent of the round length, as the equation shows. They also state that achieving an advance percentage under 95 percent typically becomes very costly for the mine. As can be seen by comparing this work with the literature previously reviewed, maintaining 2 percent requires good equipment, an experienced driller, and careful drilling [12]. Because of this, one can fully appreciate the significance drilling accuracy can have on the pull of a round, and thus understand how easy it is for an operation's advance rate to fall below 95 percent.

Now that the method for estimating the advance of a burn cut has been reviewed, this author moves on to obtain an understanding of how a burn cut achieves pull. In Singh's paper, "Discussion on the Mechanisms of Cut Pulling in Underground Mines" he discusses the process in which the burn cut breaks the rock and expels it from the cavity it creates [14]. Singh stresses the importance of achieving the intended pull from the burn cut round by explaining the negative effects pull failure can cause for the rest of the heading round. The effects include poor advance, bootlegs, and unintended overbreak around the perimeters of the excavation. Singh's intent, through his research, was to determine what forms and scale of damage a poor performing burn cut can produce. Although, this is not directly related to the work being done for this project, some of the areas covered and knowledge he gained proved to be beneficial background information.

Singh completed testing on 6 foot deep burn rounds, similar in depth to the tests being done for this project, except for a slightly different pattern design. Through the blasting of burn cut holes in various stages, rather than in one continuous chronological progression, and the application of high speed photography Singh was able to observe the effects each charged hole had on the pull of the round. The first observation made from his testing was the first hole to fire pulled only 10 to 20 percent of the length of the round. Following that realization, he determined that it takes from four to six blastholes to achieve a pull closer to the round's designed depth and that with the firing of these holes 40 to 50 percent of the blasted muck is expelled from the cavity. However, Singh does note that each charged hole does fracture its surrounding rock, and that the rock requires the additional help of the succeeding holes to fully free the rock from the cut.

This information presented by Singh helped determine what scale of testing was appropriate in order to acquire accurate pull results from varied relief hole testing.

### **2.3. PROJECT'S RELEVANCE**

After reviewing the relevant literature completed in the area of burn cut pull optimizations, this author must identify where this project fits into the larger body of work. As the preceding section illustrates, there are a number of research papers that recognize the benefits of extending the depths of a burn cut's relief holes past that of the charged holes. They state that a greater pull is obtainable with the application of extended relief hole lengths than when utilizing the burn's standard design, but do not indicate that a pull deeper than the depth of the charged hole lengths is achievable. Similarly, the literature does not attempt to quantify the benefits the researchers observed in the application of these extended holes. This project intends to expand the research in these areas by identifying, measuring, and predicting this extended cut pull. The findings of previous burn cut work conducted on the effects of rock type, drilling deviation, and pattern design are utilized in order to improve the success of the pull optimization project.

### 3. EXPERIMENTAL METHOD

In order for the results obtained from this burn cut project to hold significance, the reader first needs to understand how the experiment was conducted. This section outlines the burn cut being utilized and the conditions in which it was tested. A detailed account of how the author carried out the tests and collected the pertinent data is also provided.

#### 3.1. TESTING LOCATION

The author completed all tests underground at the Missouri S&T Experimental Mine. The author and research assistants drilled all rounds along the ramp accessing the second level of the mine. The rock in this section, as well as in the rest of the Experimental Mine, is dolomitic limestone. This limestone contains many bedding planes and, in areas, can contain zones of clay and pyrite deposits. For the purposes of proper testing and the collection of good data, the drillers avoided these zones of irregular ground. The author completed testing in two adjoining seams, one above the other. In areas where it was possible, the drilling team smoothed out the existing face, either through manual or mechanical means. Hammers and a Bobcat's hydraulic rock pecker attachment were employed as necessary. A mine map detailing the exact location of testing as well as a photograph depicting that section of the mine is depicted in Figure 3.1. Additionally, examples of the zones of irregular ground avoided during testing are shown in Figure 3.2.

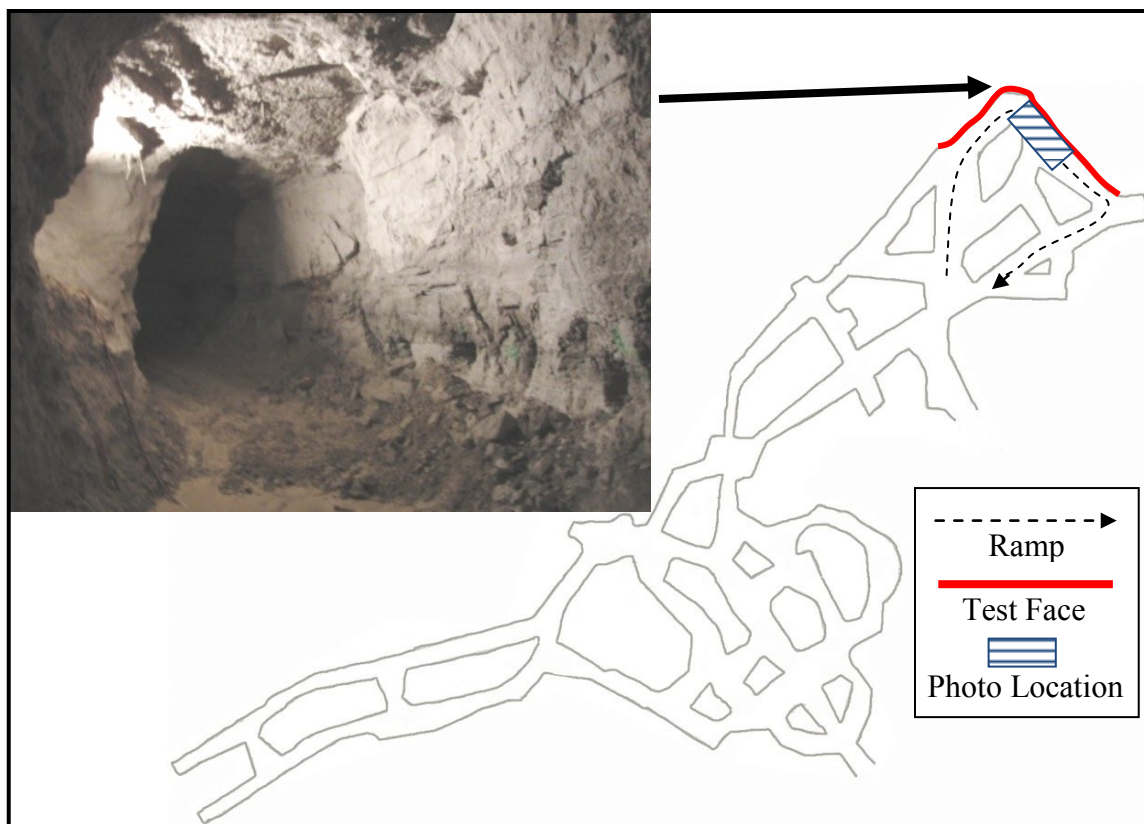

Figure 3.1. Mine Map and the Photo of Testing Area  
 (The test face where testing was conducted is identified on the mine map and depicted in the photo. The square holes left by testing can be seen on the right side of the drift in the photo.)



Figure 3.2. Clay and Pyrite Zone  
 (Example of irregular rock areas located in this section of the Mine)

Because of the accessibility of rock faces on hand at the Experimental Mine and the equipment available for use, limitations were placed on several aspects of the testing process. The first limitation was set on the size of the burn cut rounds which could be tested. Due to a finite amount of available rock face in the underground, as well as equipment capable of mucking out the mine in a timely manner, the size of the test cuts was limited to a rock face surface area of only a few square feet. This, as calculations later revealed, would limit testing of only the first two squares of burn cut holes. The drilling equipment available for underground drilling at the mine placed a second testing limitation. Due to the narrowness of the drifts in the mine, drilling was restricted to jackleg only. Utilizing jackleg drills consequently limited testing boreholes to small diameters, increasing the chances of drilling deviation. These elevated chances of encountering drilling deviation required additional precautionary measures, which will be discussed in detail in later sections.

### **3.2. BURN CUT DESIGN**

The initial area covered in the testing process is the selection of which burn cut design to utilize. The author shows how previous literature as well as the mine's limitations played a role in the selection and dimensioning of the design pattern.

**3.2.1. Pattern Selection.** In designing an underground heading blast, there are a large number of different burn cut patterns that can be chosen as the opening cut in the round. The author selected a variation of the pattern classified as the cat-hole [2]. The design contains nine holes, each drilled at the same diameter. Consisting of five charged holes and four relief holes, this pattern was utilized throughout the testing process. The basic layout of the pattern can be seen in Figure 3.3.

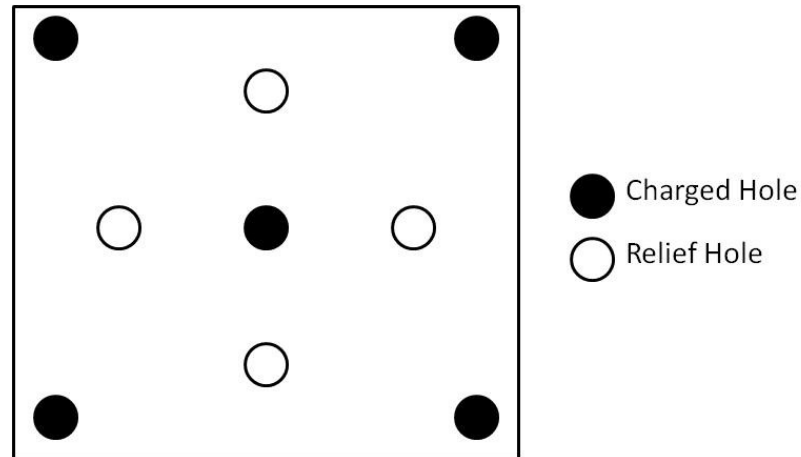

Figure 3.3. Cat-Hole Cut - Hole Layout

The author specifically selected this pattern for two main reasons. The first reason was the pattern utilized small diameter holes, which the project required due to the limitation in drilling equipment. Secondly, blasting classes and previous research projects have used a similar pattern layout for many years at the Experimental Mine, which has proven highly effective in providing the opening cut relief in narrow heading round applications [4]. With the pattern selected, the author calculated the exact dimensions of the burn cut.

**3.2.2. Burn Cut Design.** The first step in dimensioning the burn cut pattern selected for testing was choosing the hole diameter. For this project, a borehole diameter of  $1\frac{5}{8}$  inches was chosen for all holes, based on the diameter of explosive product available at the mine site. After choosing the hole diameter ( $d$ ), the author first calculated the effective diameter ( $D$ ) of the four relief holes. Equation 4 determines what effective diameter relief hole equates to the number ( $n$ ) of uncharged holes being utilized [15].

$$D = d \times n^{0.5} \quad (4)$$

After finding the effective hole diameter to be 3.25 inches, the burden of the holes in the pattern was then calculated. Utilizing Equation 5 below, the burden (a) between the center charged hole and the diamond of relief holes should be about 1.5 times that effective hole diameter [15].

$$a = 1.5 \times D \quad (5)$$

Using this equation, the author determined the burden between the center hole and the diamond of relief holes should be 5 inches. Advancing outward to the next square of holes in the burn, the distance from the center of the cut to the second square (c-c) was calculated at 10 inches through the application of Equation 6 and Equation 7. Figure 3.4 below, illustrates the values being calculated.

$$W_1 = a \times 1.414 \quad (6)$$

$$c - c = 1.5 \times W_1 \quad (7)$$

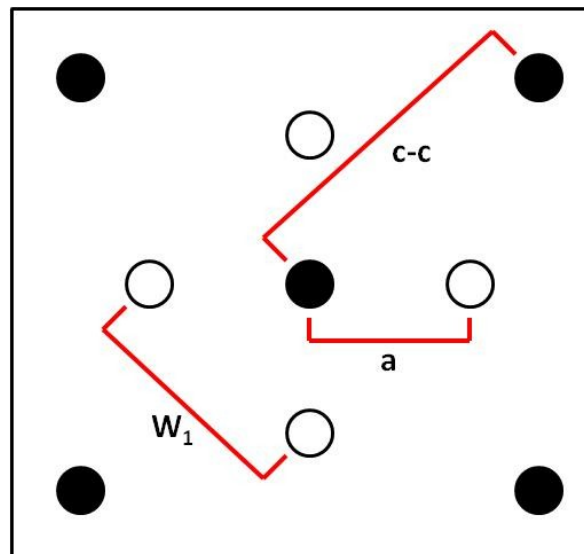

Figure 3.4. Design Calculations Illustration

With this calculation, the author determined all of the remaining dimensions for the pattern. Figure 3.5 illustrates the pattern's completed dimensions.

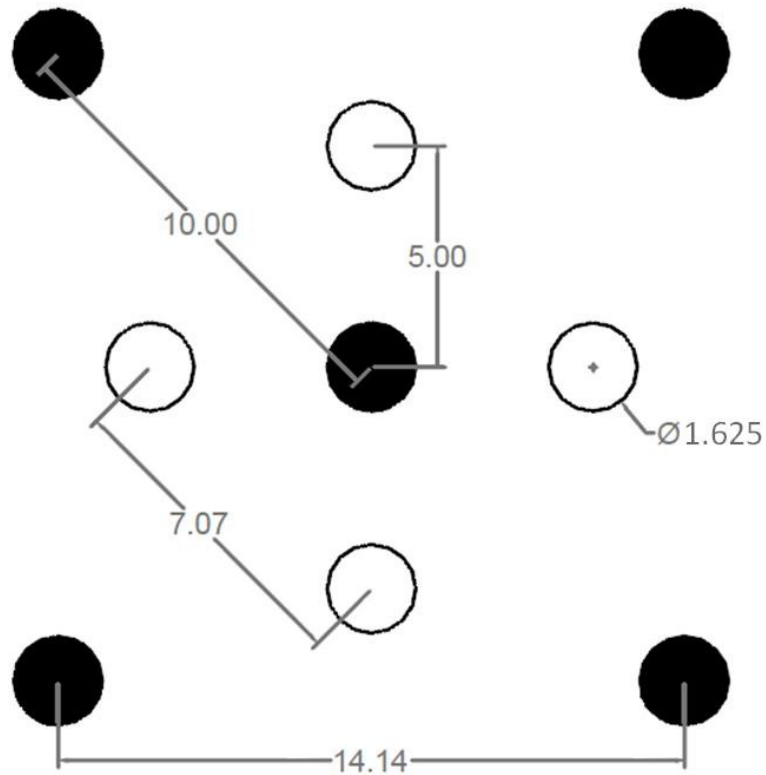

Figure 3.5. Burn Cut Design Schematic

The author used this burn cut design throughout all tests, employing a steel template in order to maintain drilling precision.

**3.2.3. Burn Cut Design Depth.** The author decided a testing depth of 7 feet would be employed for the charged holes in the round and that relief holes would be varied accordingly from there. The factors considered when selecting the hole depth were the lengths of steel available at the mine and the width of the drift in which the drilling would be done. With this width averaging at 14 feet, effectively employing steel



longer than 8 feet would be nearly impossible. Comparing the selected hole depth to the calculated maximum depth generated by Equation 2 presented in Section 2.2.3 of 8.8 feet, the author determined the chosen 7 foot depth was acceptable.

Unfortunately, due to the thin diameter of a jackleg's drill steel, deviation can become a problem at relatively short depths. The drilling team encountered high amounts of deviation on the first three rounds drilled, intersecting several holes in the shots. Because of these intersections, and the project requiring precision drilling, 6 feet was concluded to be the depth at which accuracy faltered. After this discovery, the drilling team set the standard round length at 5 feet, with variable depths extending to 6 feet. After the team realized deviation had become a problem, the author also created a custom split collet to aid in reducing hole deviation. This device will be covered further later in this section.

After the author made changes in hole depth, deviation problems were avoided for the remainder of the testing. All charged holes were drilled to a standard depth of 5 feet and the relief holes were varied from 4 feet to 6 feet. A complete breakdown of the tests is displayed in Table 3.1. In all, the team drilled twenty-three rounds, but data was not collected from the first three tests, whose deviation issues were mentioned previously. Those three are not accounted for in the table.

Table 3.1. Number of Test Rounds Conducted at Each Relief Hole Depth

Relief Hole Depth	Number of Tests
6 feet	6
5.5 feet	6
5 feet	2
4.5 feet	2
4 feet	4

### 3.3. DRILLING

**3.3.1. Drilling Equipment.** All boreholes for the test rounds were drilled using a Midwest: MWS83F Jack Leg Drill. This model of pneumatic drill runs at 100 psi (approximately 2400 impacts per minute) and uses water to lubricate and flush out the hole. The drilling team utilized  $1\frac{5}{8}$  inch, 11 degree taper, knock on cross bits for all drilling, replacing bits as necessary due to wear. The author and research assistants completed drilling using both 4 foot and 6 foot hex steels, measuring  $\frac{7}{8}$  inch in diameter. A round's designed depth determined when the longer steel was utilized. Figure 3.6 illustrates the cross bits employed during the testing process.

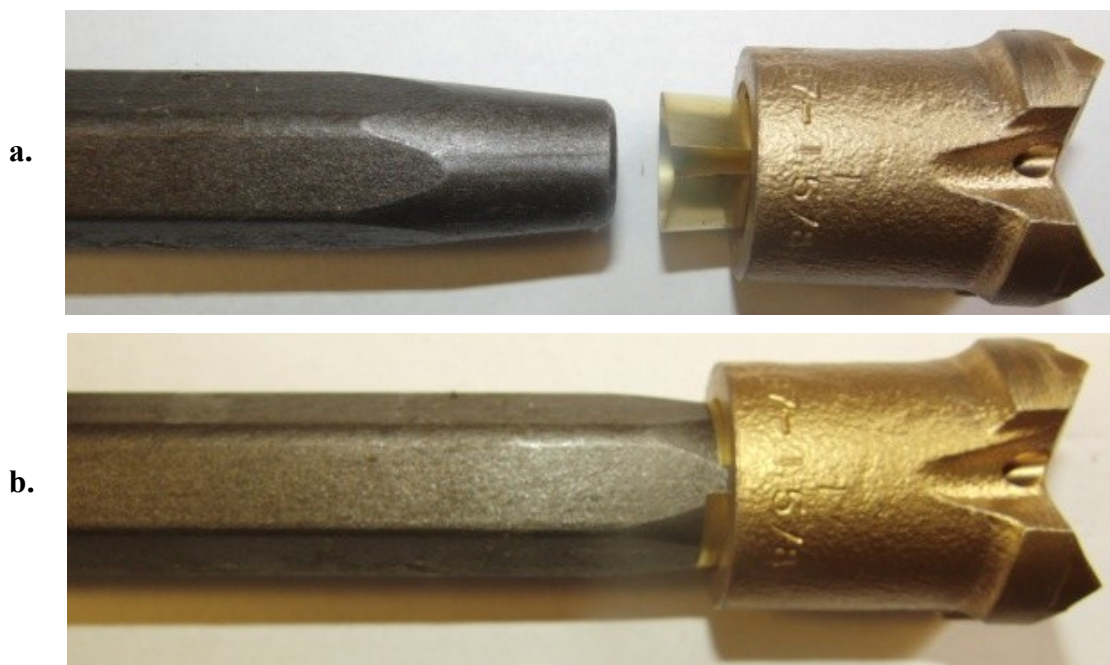

Figure 3.6.  $1\frac{5}{8}$  inch Cross Bit and Steel  
(a. Unassembled and b. Assembled)

In order to assist in the drilling of a uniform round, with holes collared in precise locations, the drilling team utilized a steel template. A University Research Engineer

crafted the template by water jet from two identical  $\frac{1}{4}$  inch steel plates. Both plates contain matching 2 inch holes positioned in the location of the burn cut's nine holes. The author bolted the two plates together, maintaining a 2 inch interior separation. This gap helped to reduce drilling deviation. The steel drilling template can be seen below in Figure 3.7. A detailed drawing of the template's exact measurements can be found in Appendix A.

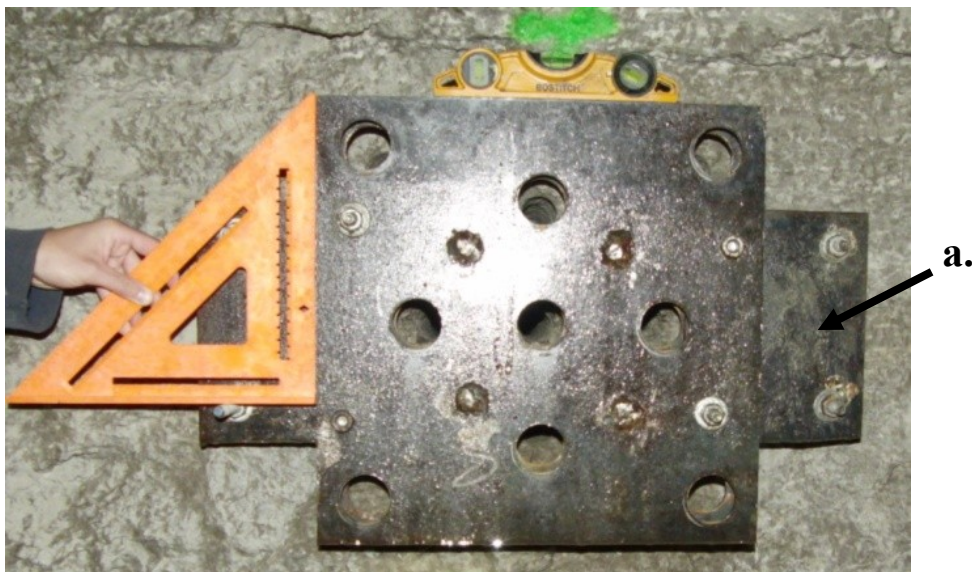

Figure 3.7. Burn Cut Drilling Template  
(a. Side plate extension for mounting to rock face)

The template also includes two side extension plates, each containing two  $\frac{3}{4}$  inch holes, which allowed the drillers to fasten it to the rock face prior to drilling, as illustrated in the figure.

In addition to the drilling template, the author had a custom steel split collet, shown in Figure 3.8, machined out of a solid steel cylinder in order to further reduce drilling inaccuracies. The detailed schematics of the split collet can also be found in Appendix A.



Figure 3.8. Split Collet

This device was necessary due to the drill bit being a larger diameter than the drill steel. Because of these differing diameters and the fact that the bit must pass through the drilling template, the steel has a large amount of vertical and horizontal play when drilling. In order to correct this issue, the author designed the split collet to lock around the steel after the drill bit passed through both of the steel plates. The driller could then slide the steel collet down the steel, allowing the thinner end to pass through the 2 inch holes in the template. This locks the drill steel in position, giving it a very limited range of vertical and horizontal movement. Both the drilling template and the split collet ensured the drilling of the pattern was performed as close as possible to the intended specifications.

The team employed two other minor tools to assist in consistent drilling with minimal deviation. The first tool was a magnetic Bostitch level. This level was essential to collaring a hole perfectly horizontal and perpendicular to the drilling template. The other tool used in the drilling process was a wooden dowel. When placed in the nearest previously drilled hole, the dowel served as a guide to the driller. It allows the driller to

visualize the direction (azimuth) of the other holes and align the current hole with prior holes.

**3.3.2. Drilling and Mounting the Template.** In order to use the drilling template in an effective manner, the user first secures it to the selected rock face. This process contains multiple steps and requires a two man team, consisting of the author and an assistant, to complete. The steps were as follows:

1. A  $\frac{7}{8}$  inch hole was drilled at least 3 inches into the face using an electric hammer drill.
2. A  $\frac{1}{2}$  -13 korker was inserted and hammered into the back of the hole and then visually inspected to ensure the anchor was secured at the back of the hole.
3. A  $\frac{1}{2}$  - 13 ready rod 12 inches in length was then screwed into the anchor. Vice grips were used to tighten it securely. Figure 3.9 illustrates the korker and all thread utilized.



Figure 3.9. An Example  $\frac{1}{2}$  - 13 Ready Rod and Korker

4. The template was then placed on this rod, using one of the side extension plate's top holes.



5. The magnetic level was used to manually level the plate.
6. While the research assistant held the template level, the locations of the three remaining anchor points were marked into the rock using a hammer and punch.
7. Steps 1-3 were repeated for each of the three remaining holes.
8. Once all the rods were in place, they were threaded through the template.
9. Nuts, lock washers, and flat washers were employed to fasten the template into position (~4 inches from the rock face).
10. Using the magnetic level, the nuts were adjusted until the face of the template was level in the vertical plane.

A fully mounted and leveled template can be seen in Figure 3.10 below.



Figure 3.10. Mounted Drilling Template

**3.3.3. Drilling the Burn Cut Pattern.** After the team mounted the template, the drilling of the pattern began. Again, as in mounting the template, drilling required a two man team, a driller and an assistant. The driller was responsible for maneuvering and controlling the jackleg, while the assistant helped with leveling, drill steel transitions, and collaring. The process for drilling the burn cut pattern was as follows:

1. The 4 foot steel was inserted through the first hole in the template. Then the split collet was clamped around the steel and slid through the template.
2. Using the level, the assistant advised the driller on raising or lowering the drill in order to reach level. Figure 3.11 shows the results of Steps 1 and 2.



Figure 3.11. Inserting the Split Collet and Leveling the Steel

3. Once the steel was level, the hole was collared.
4. After collaring was completed, the level of the steel was rechecked and corrections were made, if necessary.
5. The hole was drilled to full length, and then the steel was pulled out of the hole.
6. Steps 1-5 were repeated for each of the 9 holes in the pattern.
7. A wooden guide pole was placed in the nearest previously drilled hole, in order to help the driller maintain a straight hole.
8. The 4 foot steel was then replaced with the 6 foot steel.
9. All the holes were extended to the depth required for that design.
10. If necessary, the template was removed in order to drill the last few inches of the hole.

After the team drilled all nine holes in the burn cut round, they drilled two more holes as reference points, 1 foot above the pattern. These reference holes were drilled to a depth of at least 3 feet, a length determined sufficient enough to still be present even if the testing slabbed the rock face off around the pattern. The assistant then measured these reference holes from the back of the hole to the plane in which the burn cut was drilled. The author recorded the measurements, so the team could determine the location of the plane after the round had been fired. An example of the location of these two holes can be seen circled in Figure 3.12 below.



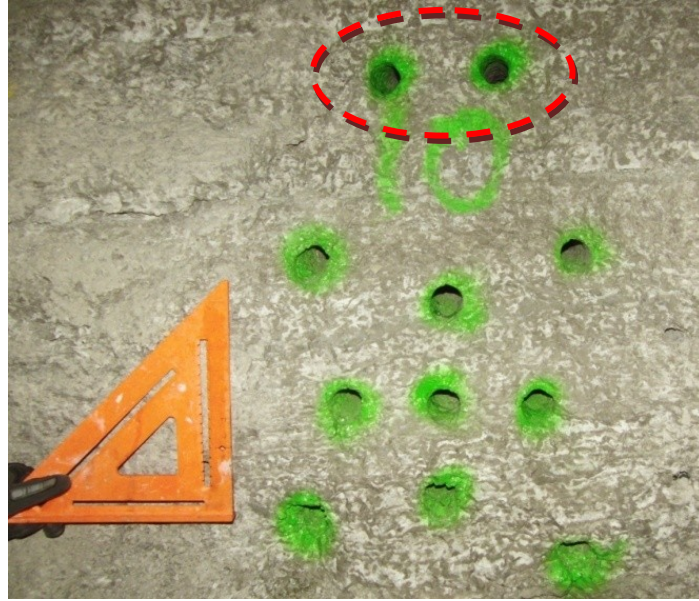

Figure 3.12. Reference Holes  
(The reference holes are circled)

When the driller completed all the holes, the author used a water hose and PVC blow tube to wash out each of the holes in the round. Clearing out all rock, fines, and debris aided in the loading process and ensured that the explosives reached the very back of the charged holes.

### 3.4. LOADING THE ROUND

**3.4.1. Explosive Product.** Each of the test cuts utilized three explosive products. The first explosive employed was the UNIMAX TT, which the manufacturer, Dyno Nobel, describes as extra gelatin dynamite with a high detonation velocity (approximately 17,400 feet per second) and good water resistance [16]. Designed to be used as either a main explosive charge or as a primer, the UNIMAX came in paper cartridges measuring  $1\frac{1}{4}$  inches by 8 inches and weighing 0.5 pounds. The product's density is 1.51 grams per cubic centimeter and Relative Bulk Strength is 2.10. The author used UNIMAX to prime each of the 5 charged holes.

POWERMITE was the second product used in the rounds. It is another packaged explosive manufactured by Dyno Nobel, but is an emulsion rather than dynamite [17]. It is also cap sensitive, water resistant, and a high energy explosive. Dyno designed POWERMITE for underground blasting in medium strength rock types. The POWERMITE cartridges used in testing measure 1½ inches by 16 inches and weigh 1.08 pounds each. The product has an average density of 1.15 grams per cubic centimeter and a Relative Bulk Strength of 1.26.

The final product used in each of the tests was Orica's uni tronic™ 600 electronic detonators [18]. Fully programmable from 0 milliseconds to 10,000 milliseconds, the uni tronic™ 600 allows for precise timing for the round, with relatively no cap scatter compared to nonelectric or electric detonators. The detonators contain 900 milligrams of explosive and come in various leg wire lengths. The detonators in this testing all had 30 foot leg wires. Along with the detonators, the user requires a scanner, blast box, and lead in wire in order to utilize the uni tronic™ 600 system.

The technical data sheets for all three explosive products used can be found in Appendix B.

**3.4.2. Loading Procedure.** The author completed all loading throughout the testing process in an identical manner. The method of priming and loading the rounds is outlined below:

1. Each of the charged holes was loaded with one stick of UNIMAX, primed with one of the uni tronic™ 600 detonators. A loading pole, marked with length measurements, was used to ensure the primer reached the back of the hole.
2. Next, two chubs of POWERMITE were loaded into the hole, one after the other. Both chubs were individually packed/tamped into the hole using the loading pole mentioned previously.
3. With the hole now containing three cartridges, a POWERMITE chub was measured and cut in half.
4. One of the halves was then inserted into the hole, severed end first.

5. The half cartridge of emulsion was tamped tight into the hole using the loading pole, ensuring it was fully coupled and no explosives would be ejected from the hole during detonation.
6. This process was repeated for each of the five loaded holes in a burn cut test round leaving 2 feet of uncharged length in each of the 5 foot holes.

On two of the 5.5 foot extended relief hole patterns, Tests 18 and 21, the pattern's center hole was reverse primed. The author completed this variance in the loading process in order to determine if reverse priming would have a noticeable effect on the pull of the burn, as suggested in previous literature. The loading order for these two holes placed the two full sticks of POWERMITE in the hole first, then the UNIMAX (cap pointing towards the back of the hole [19]), and finally the half stick of POWERMITE in order to secure the primer in place. Figure 3.13 illustrates this reverse priming method in comparison to the standard method.

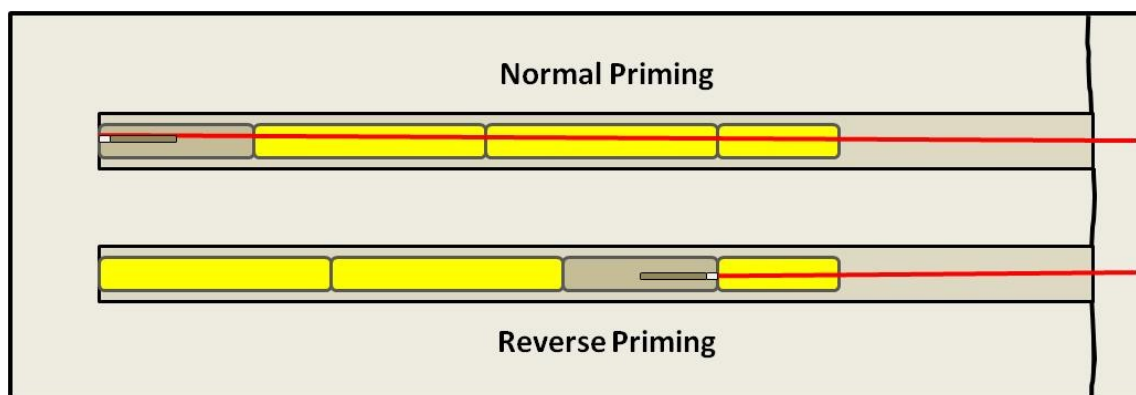

Figure 3.13. The Two Priming Methods  
(The normal priming method shows the primer positioned at the back of the borehole, while the reverse priming method depicts the primer at the opposite end of the powder column.)

**3.4.3. Round Timing.** After loading all 5 holes, the author scanned and assigned a delay to each of the detonators. The steps used by the research team were as follows:

1. Each detonator's bar code was scanned using the Scanner 200. To simplify the process, the detonators were scanned in the order they were intended to fire.
2. After a detonator is scanned, the Scanner 200 prompts for a nominal delay time to assign to that uni tronic™ 600's ID. The timing of the detonators then proceeded in a 25 milliseconds incremental manner, spiraling outward from the center hole in the round. An example of a possible timing sequence used for a round is shown below in Figure 3.14.

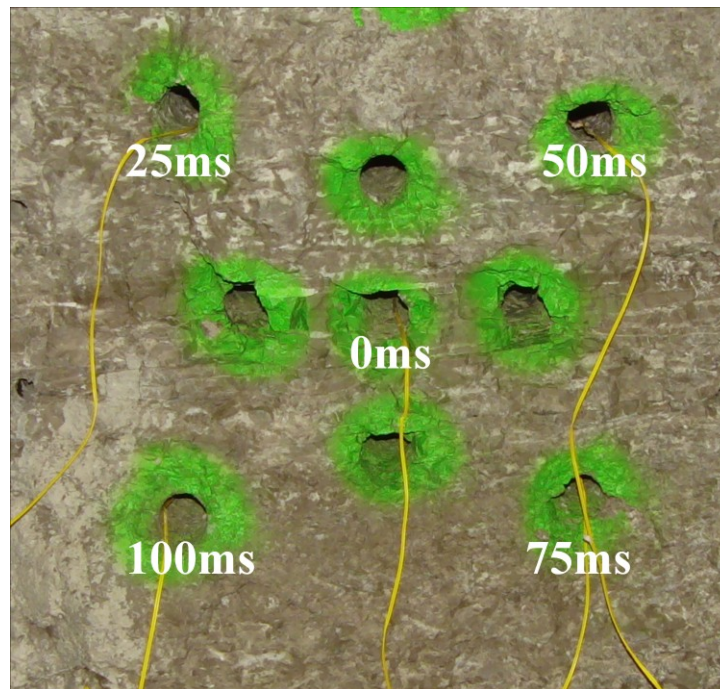

Figure 3.14. Typical Delay Times on Rounds

Any multiple of this delay pattern (example: 1000, 1025, 1050, 1075, 1100 milliseconds) can be used when conducting more than one test in a single blast sequence. For testing, a minimum of 900 milliseconds was placed between individual test shots.

This allowed each round to be clearly identified on a seismograph report of the shot. The delay times between burn cuts were increased if the number of rounds being shot permitted it. The team also varied the location of the highest delayed hole in the spiral pattern throughout testing, in order to observe its effects on the rounds.

**3.4.4. Firing Procedure.** Once the author finished loading all the burn rounds and all the detonators were scanned, the hook up and firing procedure began. This process went as follows:

1. Each of the uni tronic™ 600s was clipped into the lead wire, an Orca distributed product specifically for use with their electronic detonators. The order in which the detonators were clipped did not matter, due to the way Orca designed the uni tronic™ 600 system.
2. Once all the detonators were clipped in to the lead wire, the wire was run to the firing position.
3. Next, the detonator IDs and their previously assigned delays were downloaded from the Scanner 200 into the blast box.
4. Finally, the lead wire was hooked up to the blast box and the circuit and detonators were checked. If the device found no problems, the shot was armed and fired.

### 3.5. DATA COLLECTION

After firing each round or series of rounds, the data collection process began. The three main methods of data collection utilized included photography, bootleg length measurement, and full burn cut measurement and sketches. The main goal in this data collection was to quantify the average percentage pull in each round.

**3.5.1. Mucking out the Cut.** Immediately after shooting the test rounds, the results of the test were photographed using a Casio EX-FH25. The photographer took pictures of the rough results of the shot using a square as a 1 foot scale reference in the photos. After capturing these pictures, the muck out process began. Utilizing shovels, hoes, and the water hose and PVC nozzle used during the hole washing process, the hole left by the cut was cleaned out. Due to the short distance between the rounds and the

pillars located across the drift, on firing, rock tended to reflect back into the cut, more than typically expected with a standard burn cut. This situation was unavoidable due to the limited available testing locations at the Missouri S&T Experimental Mine and resulted in more loose material left in the cut at the end of the blast, but did not affect the pull of the cut. Any material that was easily diggable with hand tools or could be washed out of the hole was removed.

**3.5.2. Photographing the Cut.** Once the hole was clear, each cut was again photographed. As might be expected, photography in an underground environment is limited by the lighting available. Lighting becomes an issue, particularly when capturing the back of a burn cut hole with a light source coming from only one direction (the direction of the camera). This lighting issue causes problems with depth perception at the back of the cut. Alternative forms of lighting, other than camera flash, were investigated, but did not prove beneficial. Because of this, the decision was made to hand sketch profiles with depth measurements for each test cut.

**3.5.3. Measuring Bootleg and Pull.** In order to accurately measure the depth of bootleg at the back of a 5 foot burn cut hole, a novel method was developed utilizing two pieces of PVC pipe, one 0.75 inch in diameter and 118 inches long and the other 1.5 inches in diameter and 66 inches long. The small piece passes through the larger pipe. By setting one end of each pipe in line and then marking the other end of the long pipe with inch measurements starting at the end of the larger diameter pipe, a measuring device was created that was easy to read even when used at the back of the cut. The length that the smaller tube slid out past the larger diameter pipe was readable at the opposite end of the device.

The end of the larger diameter pipe that the user would be inserting into the cut was widened with tape, so that it could not pass into a bootleg. When measuring with the device, the operator simply slides the smaller pipe into a bootleg, being careful to make sure it reaches the very back of the hole, and then slides the larger diameter outer pipe down until it reaches the rock at the collar of the bootleg. The point at which the larger diameter pipe first hit the rock surface around each bootleg, while holding the device square with the cut, was consistently used as the measured collar location. A picture of the measuring device employed can be seen in Figure 3.15.





Figure 3.15. Measuring Pole in Use

Further images of the measuring pole can be found in Appendix C. Each bootleg was measured in this manner throughout the test process. With each measurement recorded, an average pull based off of bootleg was determined for the shot. This process was used for data collection on all of the extended tests.

In the shortened relief hole tests, measuring bootlegs of the charged holes would not always prove a productive way of measuring the effective pull of the shots. Because of this, two different methods were utilized for these rounds. The first method employed was similar to that used for the extended rounds, but differed in the fact that there were few bootlegs left in the shortened rounds and the bootlegs left came from the charged holes in the rounds, rather than the relief holes. In some cases, the hole with the greatest delay also left a crater in its corner of the cut. If a full bootleg or crater was found that reached to the entire 5 foot charged hole depth of the pattern, it was used as the point of reference for measurements. For craters, a point on the crest of the crater was designated

as the “collar” of the hole and was utilized for reference measurements. Then using all the measurements in relation to the collar of that bootleg the average pull was calculated. If unable to identify a bootleg or crater that extended to the full 5 foot depth, the second method of measuring was utilized. The second method required measuring the depth of rock that the blast removed rather than the amount of rock that it left behind at the back of the cut. In order to take these measurements, the original rock face was located through the use of the two reference holes drilled above the burn pattern. Through measurements of the reference holes and simple calculations, the author found the original face, and then measured the depth of the back of the cut from that plane. These measurements were taken by first hanging a plum bob at the determined plane location, from a piece of rebar placed in the reference holes above the cut. Then multiple measurements were taken with a measuring tape from the plane to the back of the cut. When needed, this method also assisted in verifying that the craters and bootlegs utilized in the first measurement method extended to the full 5 foot depth. The collection of data for all the shortened burn cut tests was gathered through these two methods.

For the entire measuring process a precision of  $\pm 0.25$  inch was set. This value was determined by observing the variability present in measuring a rock face. With uneven and inconsistent surfaces being measured, the author found it impossible to assign a value more specific than  $\pm 0.25$  inch to any measurement taken. Furthermore, the fact that the measuring took place at the back of a 4 to 6 foot deep cut hole also complicated the collection of a more precise value. It should also be mentioned that all measurements for this project were taken by the author in a consistent manner. The measuring process was standardized as much as possible in order to maintain the veracity of the data collected.

**3.5.4. Profiling the Back of the Cut.** As mentioned earlier, due to the lack of a precise method of photographing the back of the test cuts, profile sketches were made for each round. Again the application of the measuring pole determined the depth/topography of the back of the cut. The profiler selected a known point of reference and measured everything in relation to that point. In cuts with relief holes drilled shorter than the charged holes, this point was normally selected to be the crater in the back of the cut made by the last hole to fire in the round. Because it had more relief than the previous



holes, this hole tended to pull to its full 5 foot depth. In the case of rounds with relief holes drilled deeper than the charged holes, the collar of the bootleg left by the top relief hole was typically selected as the point of reference. The profiler measured and recorded the depths of the other areas in the hole in relation (either plus or minus) from this point. When dealing with the rounds with all holes drilled uniformly to 5 feet, the profiler picked one of the backs of the holes if visible, or the deepest point in the cut as the point of reference. Either way, the depths of the back were recorded in the same manner as the other two cut variations.

When sketched out, a general profile for the back of the cut is created. This profile was used to determine an average pull calculation in cases where the bootleg calculation does not provide an adequate profile representation. An example of a profile sketched for Test 9 can be seen in Figure 3.16 below.

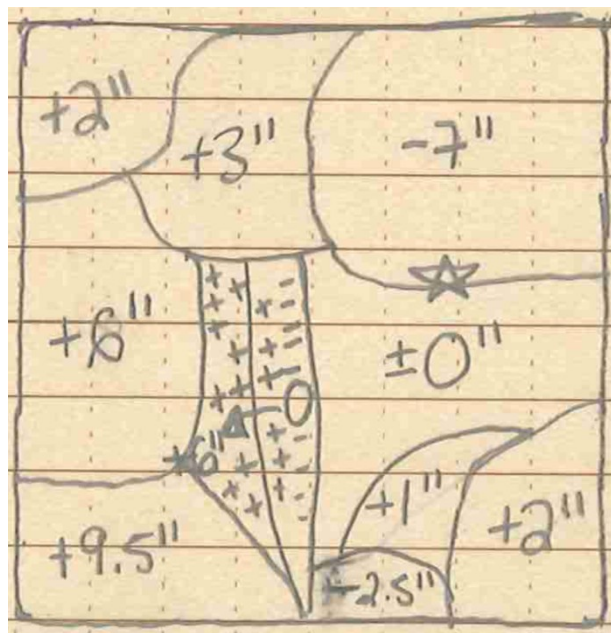

Figure 3.16. Profile Sketch Example

(The illustration depicts the profile sketch of Test 9's results. All measurements are taken in relation to the "star" (the collar of the top right crater) in the sketch and are recorded as + (less pull) or - (more pull) from that point.)

## 4. RESULTS

Now that the reader understands how and why the burn cut project was conducted, the author presents the results of each variation in the testing process. This section provides the results of the baseline, shortened, and extended rounds as well as offering the observations on the delay and reverse priming variations.

### 4.1. BASELINE TESTS

In order to determine what the baseline results for the standard application of the burn cut pattern at this hole diameter and in this particular section of limestone in the mine were, several tests were completed at the uniform depth of 5 feet. Designed to identify bootleg and other shot limitations in a pattern drilled with all holes to an identical depth, these rounds were drilled and loaded in the same manner as all other test rounds. In total, the team drilled and shot two of these rounds. After two rounds, with identical results, the author determined that testing was ready to move forward into patterns with varied relief hole lengths.

The testing of the two baseline rounds produced results very similar to what this author expected. Both tests pulled to the designed depth of 5 feet. The back of the shots contained zero bootleg, but the back surfaces of several loaded holes in each round could be identified due to soot left behind from the dynamite used to prime each hole. The face, which the burn created at the back of the resulting cut, had a very consistent profile. Varying only 0.75 inch in either direction from 5 feet, the back of the cut was as smooth as limestone will realistically allow. Figure 4.1 illustrates the typical cut results from the baseline tests.



Figure 4.1. Typical Baseline Relief Hole Round  
(This picture of Test 10's results illustrates the uniform profile at the back of the cut, containing no craters or bootlegs)

## 4.2. SHORTENED RELIEF HOLE TESTS

Testing employed two depth variations in examining the effects of shortening the relief hole of the burn cut. The investigation included both 4 foot and 4.5 foot relief holes, while maintaining the 5 foot charged hole length and the standard explosive loading procedure. In total, six rounds with shortened relief holes were shot. As the results below show, all tests resulted in reduced pull in comparison to a baseline 5 foot round.

**4.2.1. Burn Cuts with 4 Foot Relief Holes.** The first shortened length tested was the 4 foot iteration. These rounds did not perform as well as the baseline cuts. All pull measurements were collected through the two methods described previously in the Experimental Methods section. After collecting all data from the rounds, the effective pull was calculated for each cut. This process was done by dividing the back of each cut into five regions. Each region correlated to where the team originally drilled one of the charged holes. Figure 4.2 depicts the regions used for this process.

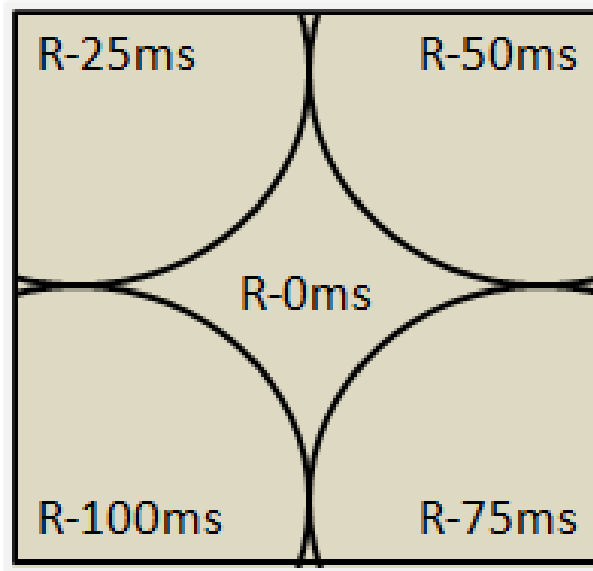

Figure 4.2. Shortened Relief Hole Cut Regions Diagram  
(Each region of the cut is designated by the delay of the hole the region contains)

The author determined the average pull in each region based on measurements taken for the profile sketch of each round. After obtaining the pull for each region, the same averaging process was completed for five regions, resulting in a pull for the entire round. The complete pull data for each of the 4 foot rounds can be found in Appendix D. The average pull depth for the 4 foot rounds can be seen below in Figure 4.3 and percent pull is displayed in Table 4.1.

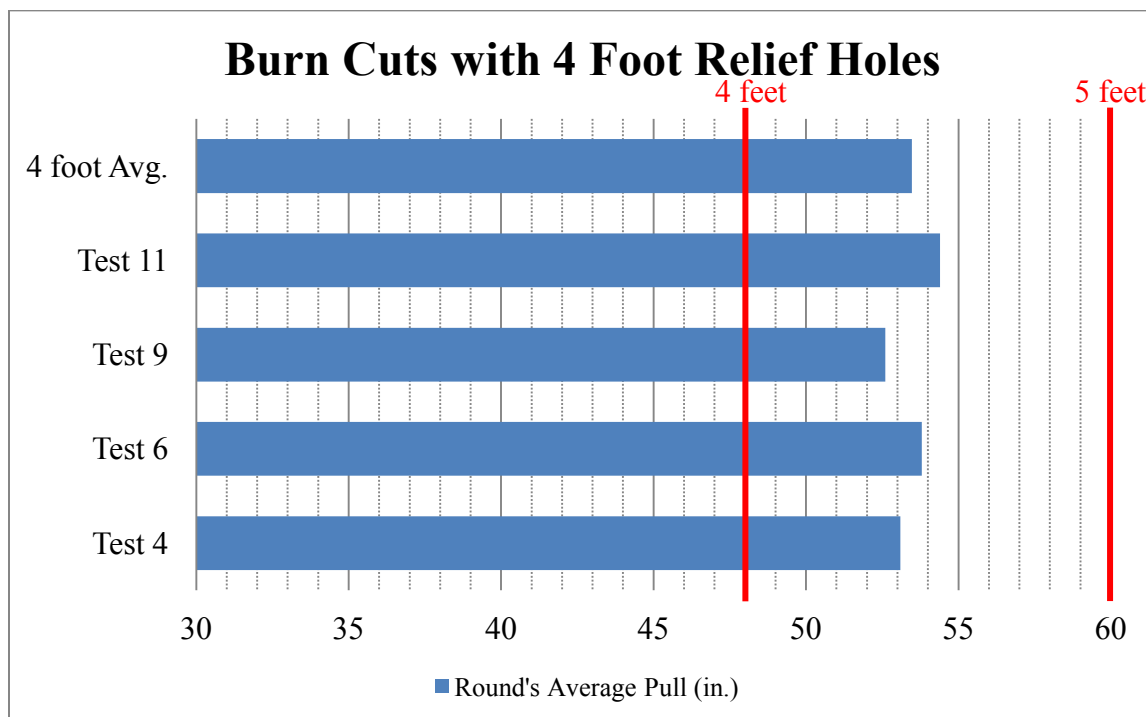

Figure 4.3. Pull Results - 4 Foot Relief Hole Burn Cuts

Table 4.1. Pull Percentages for 4 Foot Relief Hole Tests

Burn Cuts with 4 Foot Relief Holes		
Test Number	Pull Average (ft.)	Percentage Pull
Test 4	4.43	88.5%
Test 6	4.48	89.7%
test 9	4.38	87.7%
Test 11	4.53	90.7%
4 foot Avg.	4.46	89.1%

As the figure shows, the average pull for all of the 4 foot rounds is 53.48 inches. This value equates to an average percentage pull of 89.1 percent. With a full foot difference between the backs of the charged holes and the backs of the uncharged holes, the relief necessary for good breakage was not present. Because the 4 foot rounds were

missing relief at the back of the cut, where the blast is initiating, the back of the shot is frozen. This in turn did not allow the shot to expel material outward fully creating even more relief problems. Examining the results during the cleaning and measuring process revealed a large quantity of packed material in the corners of the cut. Since the material was not properly expelled, the proceeding delayed holes packed the previously blasted material into the opposite sides of the cut. When clearing the cut out, some of this material was loose and easily removed, but other sections were packed hard and thus left for the measuring process.

**4.2.2. Burn Cuts with 4.5 Foot Relief Holes.** After examining the results of the 4 foot relief hole burn cut, it was determined that a few 4.5 foot rounds should be tested in order to examine the effects of shortening the distance between the backs of the charged hole and that of the relief holes. The author tested two rounds of this variation to examine the effect the change would have on pull. When measuring the results of these rounds, only the second method described previously in Section 3.5.3 was used, due to the lack of clear bootlegs. Again, the average pull for these rounds was calculated using the five regions methods. The complete pull data gathered from the 4.5 foot rounds can be found in Appendix E. Figure 4.4 displays the resulting pull averages and Table 4.2 depicts the pull percentages for the rounds.

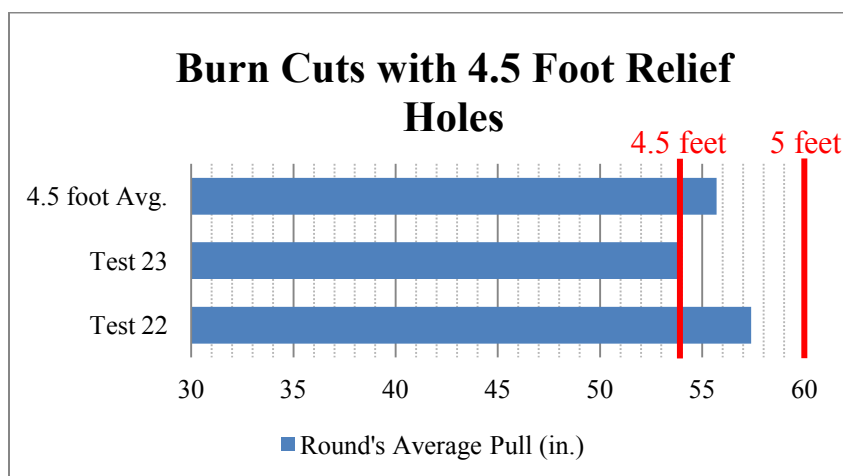

Figure 4.4. Pull Results - 4.5 Foot Relief Hole Burn Cuts

Table 4.2. Pull Percentages for 4.5 Foot Relief Hole Tests

Burn Cuts with 4.5 Foot Relief Holes		
Test Number	Pull Average (ft.)	Percentage Pull
Test 22	4.78	95.7%
Test 23	4.50	90.0%
4.5 foot Avg.	4.64	92.8%

As the table shows, the average pull values for the 4.5 foot rounds are similar but slightly better than the 4 foot rounds. The overall 4.5 foot relief round pull average is 55.70 inches, which generates a 92.8 percent average pull. In addition to similar pull depths, the 4.5 foot also shared visual results similar to the 4 foot rounds. The cuts had irregular back profiles, though not quite as poor as the 4 footers. The 4.5 foot rounds each had a section of the cut that reached the full 5 foot pull depth. These sections were larger than any found in the 4 foot rounds and their locations correlated to the firing of the highest delayed hole in the cut.

**4.2.3. Delay Timing Variations.** As outlined in the Section 3.4.3, the author used the same nominal delay times for each round, but varied the direction in which the delays would spiral outward from the center hole. The team positioned the highest delayed hole either in the bottom right of the pattern or oppositely in the top right of the pattern. After cleaning out a round, it was clearly evident in which corner the highest delay had been placed. Figure 4.5 depicts the typical results of the shortened relief hole rounds, with several visible charged hole bootlegs and one distinguishable larger crater where the last delayed hole was positioned. Table 4.3 demonstrates the average pull achieved in the region where each delay was employed.





Figure 4.5. Typical Shortened Relief Hole Round  
 (The resulting profile of Test 4 shows two bootlegs left by charged holes and one crater in the bottom left which represents the position of the last hole to fire. The back face of the cut has been painted green to accentuate its profile.)

Table 4.3. Pull Averages in each Burn Cut Region – Grouped by Delay Time

<b>Pull Averages in the Shortened Cut's Individual Delay Regions</b>		
	4 Foot Relief Hole Tests	4.5 Foot Relief Hole Tests
Delay Region	Average Pull (in.)	Average Pull (in.)
0 ms Region	53.38	56.00
25 ms Region	51.00	54.00
50 ms Region	51.25	51.50
75 ms Region	53.88	57.00
100 ms Region	57.88	60.00
<hr/>		
Avg. 0-75 ms Regions	52.38	54.63
100 ms Region	57.88	60.00
Pull Difference	5.50	5.38



As the bottom row of cells show in Table 4.3, the highest delayed hole in the shot consistently averaged over a 5 inch deeper pull than the rest of the round in both the 4 foot rounds and the 4.5 foot rounds. Figure 4.6 further illustrates the significant difference between the pull of the highest delayed holes and the rest of the charged holes in the cut.

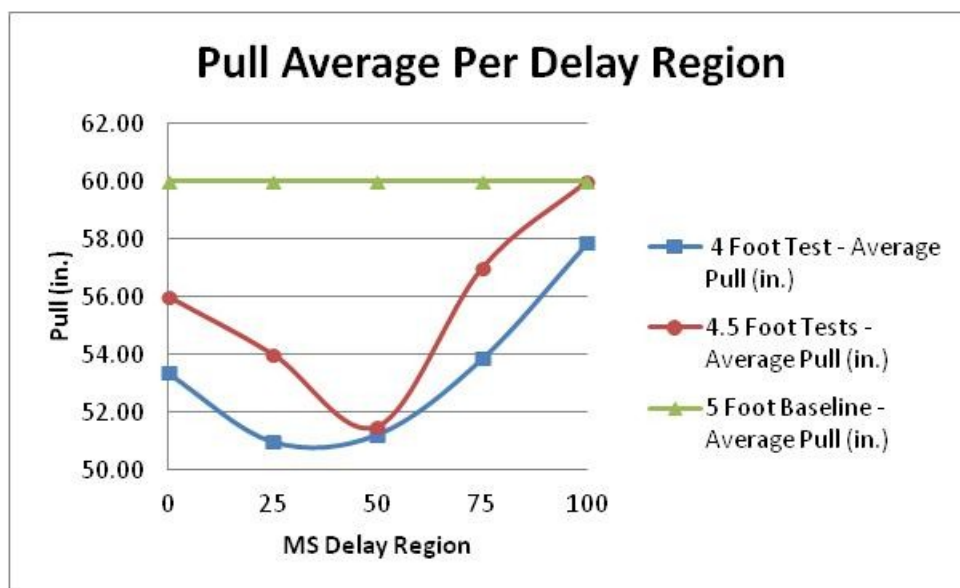

Figure 4.6. Average Pull per Burn Cut Delay Region

This plot of the regional pull averages particularly aids in the visualization of the cratering that the highest delay (100 millisecond) blast holes underwent in relation to the rest of the cut profile. The disparities present in the profile of the cut have a large effect on the overall pull average for these rounds. The author witnessed no link between the order in which the holes were delayed and an increase in the round's overall pull.

### 4.3. EXTENDED RELIEF HOLE TESTS

Two different lengths of extended relief holes were tested throughout the project. The two extended hole depths examined were 6 foot and 5.5 foot, while continuing to maintain the identical 5 foot charged hole depth and explosive loading conditions. In total, twelve burn cut tests were completed in this portion of the project. As the results will show in the following sections, these extended cuts constantly pulled farther than the baseline burn cut testing.

**4.3.1. Burn Cuts with 6 Foot Relief Holes.** The first extended relief hole length tested was 6 feet. With the relief holes reaching a full foot past the charged holes, the test was to determine if the rounds would break farther back than the standard 5 feet from the baseline testing. Testing included six replications of this burn cut variation. After measuring all of the bootlegs left by this set of tests, the data was compiled and calculations were made for the depths of pull for the 6 foot rounds, all of which can be found in Appendix F. Below, Figure 4.7 illustrates the average pull in inches for each round, while Table 4.4 shows the percentage pull as well as the calculated pull increase, in comparison to the 5 foot baseline results.

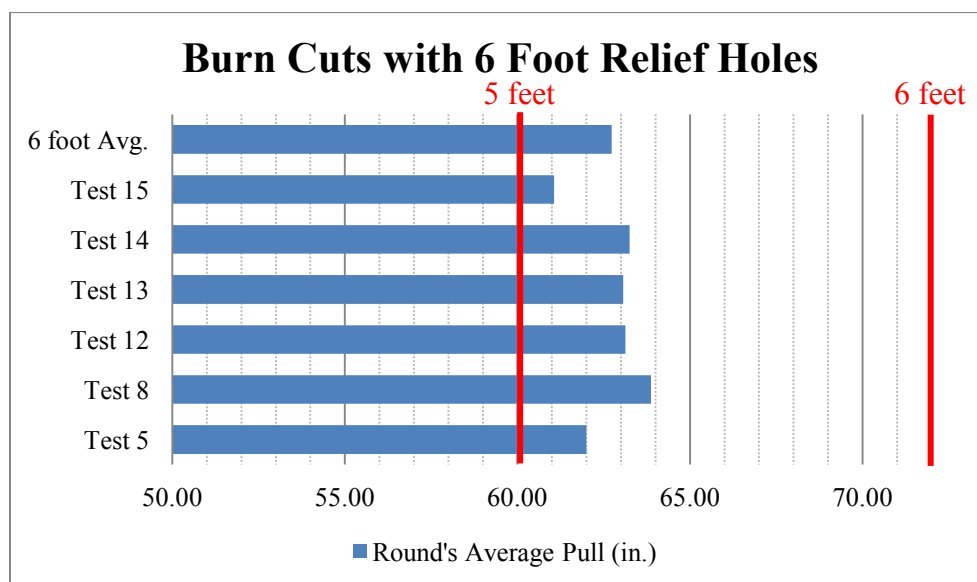

Figure 4.7. Pull Results - 6 Foot Relief Hole Burn Cuts

Table 4.4. Pull Averages for 6 Foot Relief Hole Tests

Burn Cuts with 6 Foot Relief Holes			
Test Number	Pull Average (ft.)	Percentage Pull	Increase (in.)
Test 5	5.17	103.3%	2.00
Test 8	5.32	106.5%	3.88
Test 12	5.26	105.2%	3.13
Test 13	5.26	105.1%	3.06
Test 14	5.27	105.4%	3.25
Test 15	5.09	101.8%	1.06
6 foot Avg.	5.23	104.5%	2.73

As Table 4.4 illustrates, every 6 foot burn cut pulled to a greater depth than the baseline 5 foot tests. Increasing on average by 2.73 inches, the average pull for the rounds improved to 104.5 percent.

Looking at the cut profiles left by the 6 foot relief hole rounds, a commonality can be seen in the uniformity of the centers. Typically varying only by a couple of inches within a single round, the bootlegs from all of the 6 foot rounds maintained a standard deviation of 1.41 inches. The author witnessed that the edges of the cut did contain some pull irregularities, but not as many as present in the shortened rounds. Similarly, several cases of blasted material packed into the corners of the cut were discovered, but this was much less prevalent than in the shortened relief hole burns.

**4.3.2. Burn Cuts with 5.5 Foot Relief Holes.** The final iteration of extended relief hole rounds tested was at 5.5 feet. With the knowledge that a 6 foot relief hole round would pull greater than its 5 foot counterpart, the author wanted to see what effect, if any, narrowing the difference in length between the relief holes and charged holes would have. Six more burns were shot during this round of testing. All of the data collected from the measuring of the cut's bootlegs and compilations of the pull depths for each of the rounds, can be found in Appendix G. Figure 4.8 illustrates the average pull depth for each of the 5.5 foot rounds, and Table 4.5 displays all of the resulting pull percentages for each 5.5 foot relief hole burn as well as the overall averages for all six of the burns and the pull increases in comparison to the 5 foot baseline results.

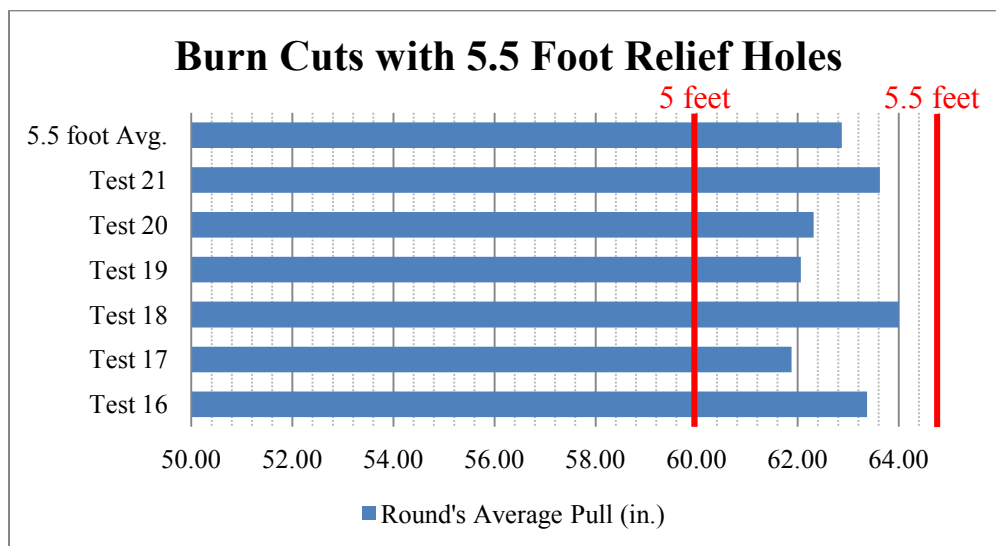

Figure 4.8. Pull Results - 5.5 Foot Relief Hole Burn Cuts

Table 4.5. Pull Averages for 5.5 Foot Relief Hole Tests

Burn Cuts with 5.5 Foot Relief Holes			
Test Number	Pull Average (ft.)	Percentage Pull	Increase (in.)
Test 16	5.28	105.6%	3.38
Test 17	5.16	103.1%	1.88
Test 18	5.33	106.7%	4.00
Test 19	5.17	103.4%	2.06
Test 20	5.19	103.9%	2.31
Test 21	5.30	106.0%	3.63
5.5 foot Avg.	5.24	104.8%	2.88

Table 4.5 reinforces the results of the 6 foot relief hole cuts, showing that the rounds achieved an increase in pull. The 5.5 foot relief rounds, in comparison to the baseline 5 foot tests, increased in pull by an average of 2.88 inches per round. This increase brings the percentage pull for the 5.5 foot rounds to 104.8 percent.

Examining the cut profiles of the 5.5 foot relief hole rounds, the author identified large similarities to that of the 6 foot hole rounds. Again the cut centers maintained a

highly uniform profile. The bootlegs from all six of the 5.5 foot rounds retained a standard deviation of 1.35 inches. In fact, the standard deviation for all twelve of the extended rounds combined calculates to only 1.37 inches. Just as in the 6 foot test, the edges of the cut did contain some pull irregularities, but not as many as present in the shortened rounds. Similarly, several instances of blasted material packed into the corners of the cut were found, but this was still much less common than in the shortened relief hole burns.

The 5.5 foot relief hole burn cut results are only slightly higher than that of the 6 foot. Averaging a 0.15 inch difference between the two round variations, the two rounds produce very similar results. Combining all of the extended relief hole round data, the pull averages out to an increase of 2.80 inches per round.

**4.3.3. Delay Timing Variations.** Throughout the tests of the extended relief rounds, the nominal delay times remained constant, but as in the testing of the shortened relief hole burns, the spiral pattern in which the author assigned the delays varied. Again, this was done in order to examine the effects it would have on the pull of the burn cuts. The location of the highest delayed hole was varied between corners of the cut. Unlike in the shortened relief hole rounds, this factor had no visual effect on the cut. Figure 4.9 depicts the normal profile results observable in the extended rounds. In order to analyze the burn results for delay timing variations, the cut was divided into four regions. These regions, displayed in Figure 4.10, are broken down by the delayed holes they are located between.



Figure 4.9. Typical Extended Relief Round  
(The resulting profile from Test 17 shows the bootleg left from each of the four extended relief holes. The back face of the cut has been painted green to accentuate its profile.)

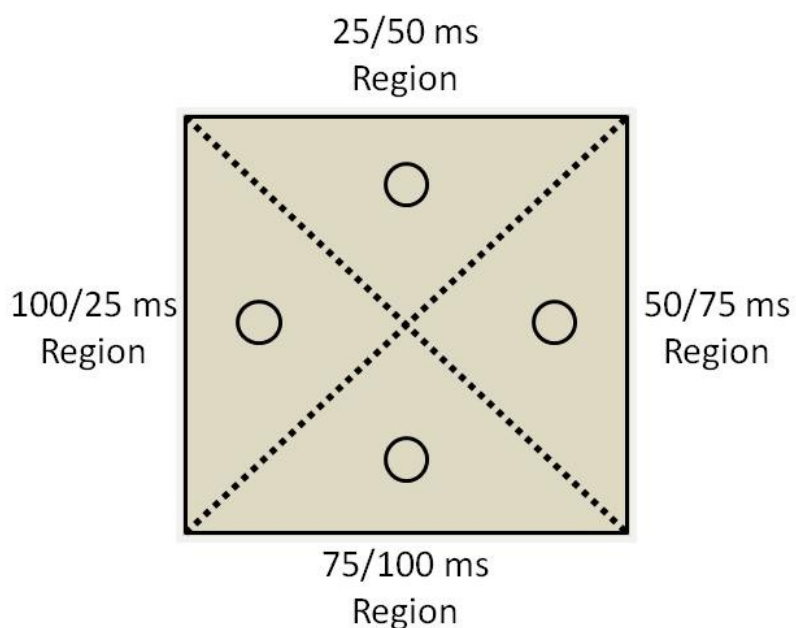

Figure 4.10. Extended Relief Hole Cut Regions Diagram  
(Each of the four regions, separated by the dotted lines, is labeled in relation to the two charged corner holes it contains.)

The cut was divided in this four region manner, rather than the five previously employed, due to the nature in which the extended relief hole data was collected. For the extended rounds, the bootlegs left by the four relief holes were the most precise areas to measure. Employing the five regions method would place all of these data points in the same region, rather than distributing them equally. Using these assigned regions, Table 4.6 details the regional pull averages and suggests the location of the highest delayed hole has no clear effect on the pull of the 6 foot and 5.5 foot extended rounds.

Table 4.6. Extended Pull Averages in each Burn Cut Region  
(Grouped by Regional Delay Times)

Pull Averages in the Extended Cut's Individual Regions		
	6 Foot Relief Hole Tests	5.5 Foot Relief Hole Tests
Delay Region	Average Pull (in.)	Average Pull (in.)
25/50 ms Region	62.58	63.50
50/75 ms Region	62.67	62.67
75/100 ms Region	62.96	63.04
100/25 ms Region	62.71	62.29

**4.3.4. Reverse Priming Results.** As mentioned in Section 3.4.2, the author intentionally reverse primed two of the 5.5 foot relief hole rounds, Tests 18 and 21, in order to observe its effects on the pull of the rounds. After examining the measurements gathered through the testing process, it was discovered that the two 5.5 foot tests that pulled the farthest were indeed the two tests that the author reverse primed. Table 4.7 illustrates that Tests 18 and 21 achieved the highest average pull out of the six 5.5 foot rounds conducted in the project.

Table 4.7. Reversed Prime Pull Averages  
(Tests 18 and 21, shown in bold, are the two reverse primed tests.)

<b>Burn Cuts with 5.5 Foot Relief Holes</b>				
Test Number	Pull Average (in.)	Pull Average (ft.)	Percentage Pull	Increase (in.)
Test 16	63.38	5.28	105.6%	3.38
Test 17	61.88	5.16	103.1%	1.88
<b>Test 18</b>	<b>64.00</b>	<b>5.33</b>	<b>106.7%</b>	<b>4.00</b>
Test 19	62.06	5.17	103.4%	2.06
Test 20	62.31	5.19	103.9%	2.31
<b>Test 21</b>	<b>63.63</b>	<b>5.30</b>	<b>106.0%</b>	<b>3.63</b>
5.5 foot Avg.	62.88	5.24	104.8%	2.88

#### 4.4. RESULTS SYNOPSIS

In all, the author shot twenty data producing burn cuts for this project, as well as gathering the data from the rounds, and making several observations on the results. First, the baseline tests proved that 100 percent pull was achievable at the 5 foot depth being tested. Then the shortened relief hole burn cuts proceeded to illustrate how severely detrimental the reduction of relief at the back of the shot can have on the pull of the round. With the 4 foot and 4.5 foot rounds averaging 89.1 percent and 92.8 percent, respectively, there is no question as to how essential the relief holes are to the success of the burn cut round. After quantifying the negative effects of decreasing the relief hole length, the author transitioned to do the same for the positive effects that an increase would have on the cut's pull. Testing not only verified that an extension in relief hole is beneficial for the pull of the burn cut, but also that it enables the cut to pull deeper than its charged holes are drilled. The 6 foot and 5.5 foot extended relief hole tests averaged just under a 105 percent pull. Additionally, it was observed that the order in which delay periods were assigned did not affect the resulting pull averages of the cuts. Finally, the results also suggested that reverse priming may contribute to added pull increase, but further testing is required to definitively answer this question.



## 5. DISCUSSION

The objective of this research project was to optimize a burn cut pattern's pull by examining the effects of varying the length of the relief holes in the pattern. The author completed testing with the intent of achieving greater pull than a standard round typically would, while holding the depth of charged holes and explosive loading constant. After the collection and analysis of all the data, the results of the project were rather revealing. The testing results found that a greater depth was obtainable and that various other factors were worth future investigation. Figure 5.1 summarized the finding of all five test variations and gives a beneficial visual representation of how each of the tests compared.

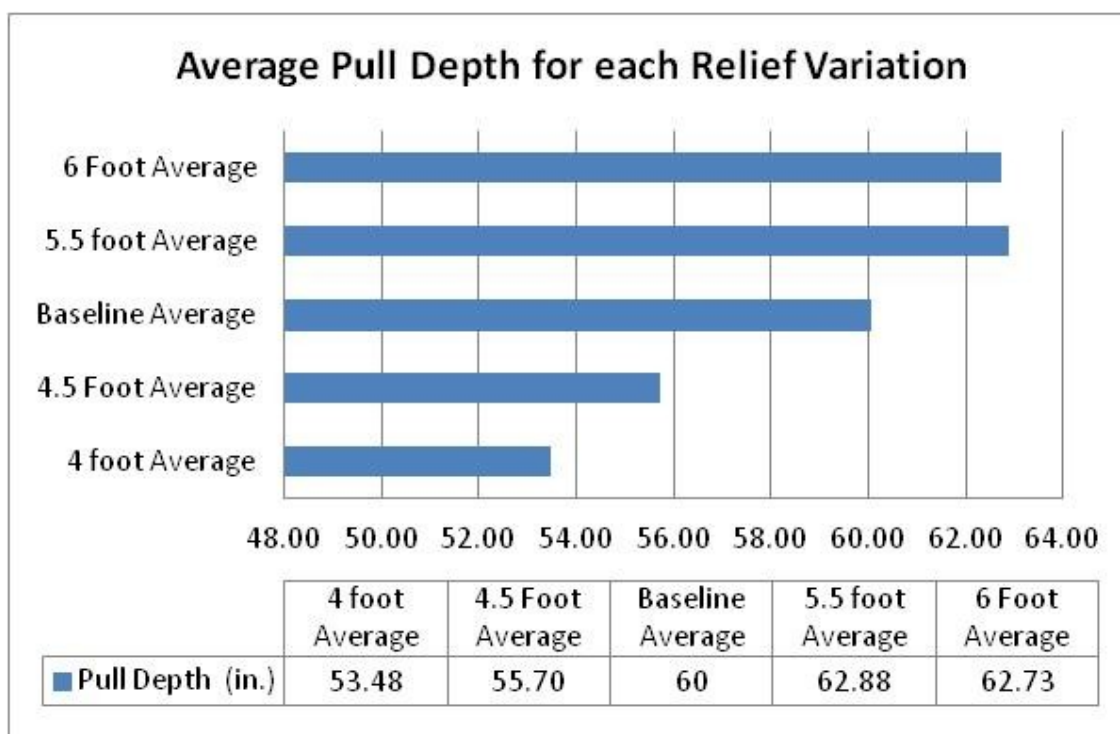
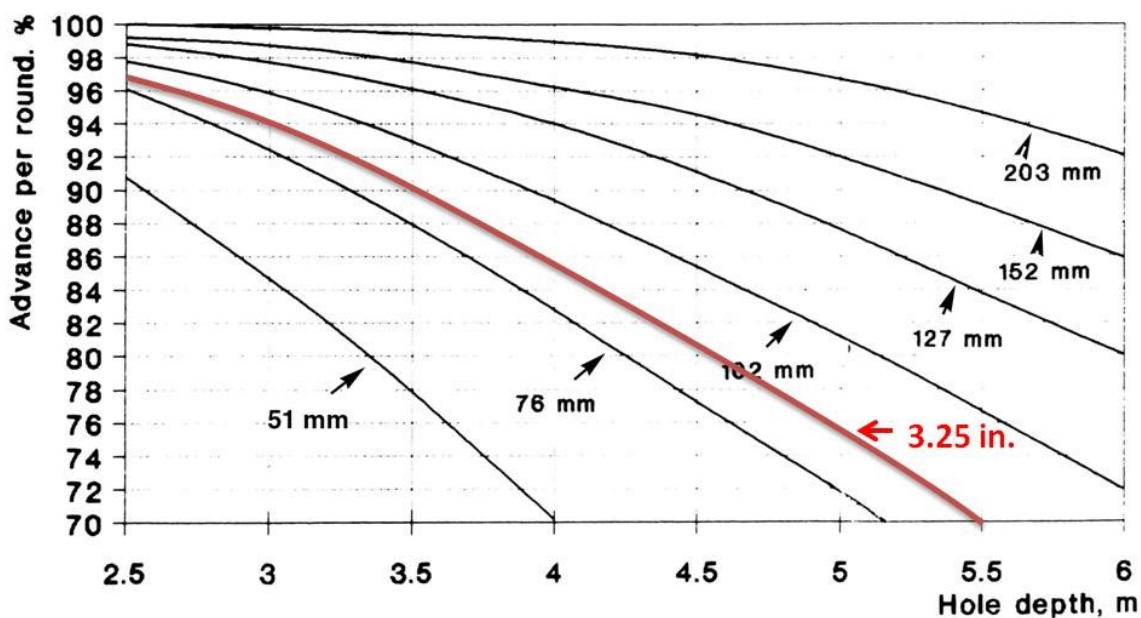

Figure 5.1. Average Pull Summary

## 5.1. BASELINE TESTS

The baseline tests conducted at the beginning of this project proved critical for setting a standard for comparison to all further testing. As stated in Section 4.1, the baseline tests revealed that blasting in the dolomitic limestone, a blaster could achieve a 5 foot pull utilizing the 5 foot burn cut in question. These results, with no bootleg and averaging 100 percent pull, provided a perfect baseline throughout the rest of testing. The author must note that the reason that pull was obtained with no bootleg is due to the short depth of the cuts tested. With longer holes, this may not prove to be the case. The chart provided in Figure 5.2 further demonstrates this concept.



*The relation between advance in per cent of the drill depth and different empty hole diameters.*

Figure 5.2. Round Advance by Relief Hole Depth and Diameter  
(From Olofsson's *Applied Explosives Technology for Construction and Mining* [20])

This chart, from Olofsson, demonstrates the effect relief hole diameter and drill hole lengths have on the pull of a standard burn cut design. The larger the relief, the higher rate of advance a specific cut depth can achieve. The 3.25 inch effective relief diameter of the round utilized in this project applied along with the short hole depth of 5 feet (1.524 m) equates to a theoretical 100 percent pull. Baseline testing proved that this was accurate.

## 5.2. SHORTENED RELIEF HOLE TESTS

As the results showed, shortening the burn cut's relief holes reduces the effectiveness of the pull. The results from this portion of the project were expected, as they are the logical consequence to draw from the design change, but the author has not seen these kinds of results quantitatively reported before. Therefore, the shortened tests were completed in order to acquire data on how the cut would precisely respond to the change. The data was examined to find if patterns existed that would help to explain the results of all the varied relief hole rounds and to use the information to optimize the round's pull in general. Two shortened variations were tested during this stage of the project.

**5.2.1. Burn Cuts with 4 Foot Relief Holes.** The first burn cuts tested employed 4 foot relief holes. A summary of these tests can be seen in Table 5.1.

Table 5.1. Burn Cuts with 4 Foot Relief Holes Summary

<b>Burn Cuts with 4 Foot Relief Holes</b>			
Test Number	Pull Average (in.)	Pull Average (ft.)	Percentage Pull
4 foot Avg.	53.48	4.46	89.1%
Standard Deviation	0.79	0.07	1.3%

The 4 foot rounds averaged a 53.48 inch pull, which is 6.5 inches less than that of the standard 5 foot baseline shot. Although, this 89.1 percent would be considered a pull poor performance by most standards, the reader must also consider that the round did pull an average of 5.5 inches farther than its 4 foot relief holes were drilled. With no area for relief around them, the charged holes essentially cratered out the first foot at the back of the round. The process by which these holes crater extends outside of the burn cut optimization work being done in this project, but is something that would benefit from further investigation. Table 5.1 also shows the standard deviation for the pull of the 4 foot rounds was rather small. Calculated at 0.79 inches, the deviation illustrates the consistency of the rounds achieved during testing and gives confidence in the validity of the results obtained.

**5.2.2. Burn Cuts with 4.5 Foot Relief Holes.** After obtaining a less than 100 percent pull from the 4 foot relief hole tests, the author determined it would be prudent to analyze the effects of decreasing the distance between the back of the charged holes and the back of the uncharged holes. The author decided upon 4.5 foot holes, cutting the distance in half. Table 5.2 summarizes the pull obtained from the 4.5 foot round of testing.

Table 5.2. Burn Cuts with 4.5 Foot Relief Holes Summary

<b>Burn Cuts with 4.5 Foot Relief Holes</b>			
Test Number	Pull Average (in.)	Pull Average (ft.)	Percentage Pull
4.5 foot Avg.	55.70	4.64	92.8%

Table 5.2 shows the average pull for the 4.5 foot rounds is 55.70 inches, which is 4.3 inches short of the baseline 5 foot average. Although coming up short compared to the baseline, these 4.5 foot shortened rounds did achieve a deeper pull than their 4 foot counterparts due to the added relief given by the extra 6 inches of drilled depth in the

relief holes. Because only two rounds were tested at 4.5 feet, the standard deviation is not a relevant value and thus was not calculated, like in the other test groups.

**5.2.3. Shortened Relief Hole Breakage Analysis.** In completing the shortened length relief hole testing, the research results support the common practice of drilling relief holes at least to a depth equal to that of the charged holes as an essential factor in the burn cut process. Without this necessary relief, the rock in the back of the cut experiences plastic deformation rather than clean breakage and the round is unable to benefit from the explosive's full potential. The normal recommendation for maximum distance between a charged borehole and relief hole is no greater than two times the empty hole *effective* diameter [1]. This distance calculates to be 6.5 inches for the burn cut design the project tested. Because of the shortened relief holes, this recommendation is not met for the full cut length in either of these round variations. If the relief from empty boreholes is not present at the rear of the cut, then the previously fired loaded holes become the cut's relief holes. Because of this, the back of the charged holes regress to cratering the rock towards the only free face and plastically deforming the rest of the surrounding rock. As these tests show, drilling the charged holes to a depth greater than the relief holes will result in a waste of time and money for the user.

### 5.3. EXTENDED RELIEF HOLE TESTS

The results prove that increasing a burn cut round's pull is possible through the introduction of extended length relief holes into the pattern. Out of the twelve extended rounds fired in the testing process, every one pulled to a depth greater than the 100 percent achieved by the baseline rounds. With this proof that extending a burn cut pattern's relief hole depth indeed benefitted the pull of the burn cut, the author examined the data for the existence of patterns to help explain the results of all the varied relief hole rounds, as well as to use it to optimize the burn's pull in general.

**5.3.1. Burn Cuts with 6 Foot Relief Holes.** The first depth chosen for the extended relief hole burn cut was 6 feet. The author chose this increase, because it corresponds to a bootleg depth that a blasting operation might expect to find in a heading round achieving an advance around 90 to 95 percent of its design depth. This connection

to industry is essential, because by extending the burn cut's pull in this one foot zone, it would directly affect the pull and bootlegs in the remaining heading round blast. By taking the burn cut deeper than the rest of the charged holes in the round, the likelihood of the rest of the round pulling 100 percent greatly increases. If this can be done without increasing the quantity of explosives utilized in the shot, then the operation excavating the rock benefits financially.

The data collected and analyzed for the half dozen 6 foot relief hole burn cuts is summarized in Table 5.3 below.

Table 5.3. Burn Cuts with 6 Foot Relief Holes Summary

<b>Burn Cuts with 6 Foot Relief Holes</b>				
Test Number	Pull Avg. (in.)	Pull Avg. (ft.)	Percentage Pull	Increase (in.)
6 foot Avg.	62.73	5.23	104.5%	2.73
Standard Dev.	1.02	0.08	1.7%	1.02

The 5 foot rounds achieved a pull of 62.73 inches on average, 2.73 inches deeper than the baseline test pull. The test's averages resulted in a standard deviation greater than that of the shortened hole rounds. Calculated at 1.02 inches, the data shows that the pull did vary slightly between the tests. One round pulled as little as 1.06 inches extra, while another pulled an additional 3.88 inches. Though, the author ideally desires a consistent value across each of the rounds, one must consider that most rock types are not entirely uniform in their strength properties, densities, and zones of weakness. These variations as well as drilling accuracy play a large role in the pull determination of any round. In a real world heading blast situation, the same factors are at work. The exact pull from one round is typically not identical, but should only vary a small amount.

Now that this project has established an average value for what magnitude of a pull increase is plausible, the reader needs to consider the industry implications.

Although 2.73 inches does not seem like a large amount of extra rock broken by the cut,

there are several factors that must be considered. First, in underground blasting where burns are utilized, most of the production does not come from this opening cut. The vast majority of the rock comes from the main part of the round. If the extra 2.73 inches allows for a reduction in bootleg in the rest of the shot, less explosive energy will be wasted and production will increase. Table 5.4 illustrates the increase in production that is possible per round with several example mine situations, if the added relief allows for a matching pull in the rest of the blast pattern.

Table 5.4. Possible Production Increases with Example Heading Sizes

<b>Example Rock Volume Increases per Round - 6 Foot Tests Results</b>			
Heading Width (ft.)	Face Height (ft.)	Extra Pull (in.)	Volume Increase (cyd.)
40	20	2.73	6.74
35	15	2.73	4.42
30	15	2.73	3.79

As seen in Table 5.4, with an increased pull of just 2.73 inches, a sizable volume of extra rock can be secured. The larger the face, the higher the potential for increased production. The only added cost for blasting the additional rock is that of drilling the extra foot or less at the end of each relief hole.

**5.3.2. Burn Cuts with 5.5 Foot Relief Holes.** As the previous series of tests demonstrated, increasing the pull of a burn cut is possible by changing only the length of the relief holes and keeping all other factors constant. Because of the success of the 6 foot round tests, the author determined decreasing the depth of the relief holes to 5.5 feet would be the next step in optimizing the burn's pull. By decreasing the length of the relief hole extensions, the plan was to examine the sensitivity that depth would have on the increased pull of the burn. Table 5.5 displays the summarized findings of the 5.5 foot relief hole cuts.

Table 5.5. Burn Cuts with 5.5 Foot Relief Holes Summary

<b>Burn Cuts with 5.5 Foot Relief Holes</b>				
Test Number	Pull Avg. (in.)	Pull Avg. (ft.)	Percentage Pull	Increase (in.)
5.5 foot Avg.	62.88	5.24	104.8%	2.88
Standard Dev.	0.90	0.08	1.5%	0.90

Detailing the findings of six 5.5 foot rounds tested, Table 5.5 strengthens the evidence that an increased pull is obtainable. As in the 6 foot test results, the standard deviation calculates around 1 inch. Again, the variability of the limestone plays a large role in creating that deviation.

In comparison to the 6 foot rounds, the 5.5 foot averaged 0.15 inch deeper pull. Since this value is small and below the level of precision used in measuring, it cannot be determined definitively that the 5.5 foot relief burns pull further than the 6 foot burns. However, the values are statistically close enough to conclude that for the burn cut pattern tested in this project, a pull increase of slightly less than 3 inches is consistently possible with the use of extended relief holes, while maintaining the charged holes at 5 feet. Furthermore, the results also suggest after a certain depth, that the length of the extension is inconsequential and will have no greater effect on the round's pull. Utilizing that determination, this author suggests that 4 inch extended relief holes is the optimal addition to the burn cut in question when utilizing  $1\frac{5}{8}$  inch holes, in order to maximize the round's pull in relation to the relief hole length exclusively. Even though the resulting average of the tests was found to be slightly less than 3 inches, the 4 inch depth will allow for the maximum pull encountered in the testing process, while still keeping drilling costs minimized. Although, with that being said, increasing the extended length past 4 inches would not be detrimental to the round's pull results and would allow for the possibility of deeper breakage in the chance that weaker rock or other unforeseen factors that might allow greater pull are present. The only negative effect of drilling these holes deeper is the added cost of drilling, which is small compared to the cost of the entire round. The exact amount of extended drilling that will be most beneficial at a specific operation is something that has to be determined through trial and error on location.



#### 5.4. ANGLE OF BREAKAGE

The author further analyzed the results of the extended relief hole pull, looking for patterns or commonalities that could assist the application of the knowledge gained in this project to that of other burn cut designs. One of the avenues evaluated, was to determine if there was common angle at which the breakage taking place occurred beyond the standard 5 foot mark. Utilizing the extended pull depths and the known burden of 5 inches located between the charged holes and relief holes, the angle ( $\theta_E$ ) at which the extended rock breakage occurred was calculated. Figure 5.3 illustrates the angle of breakage concept, and Equation 8 shows how the breakage angle was determined.

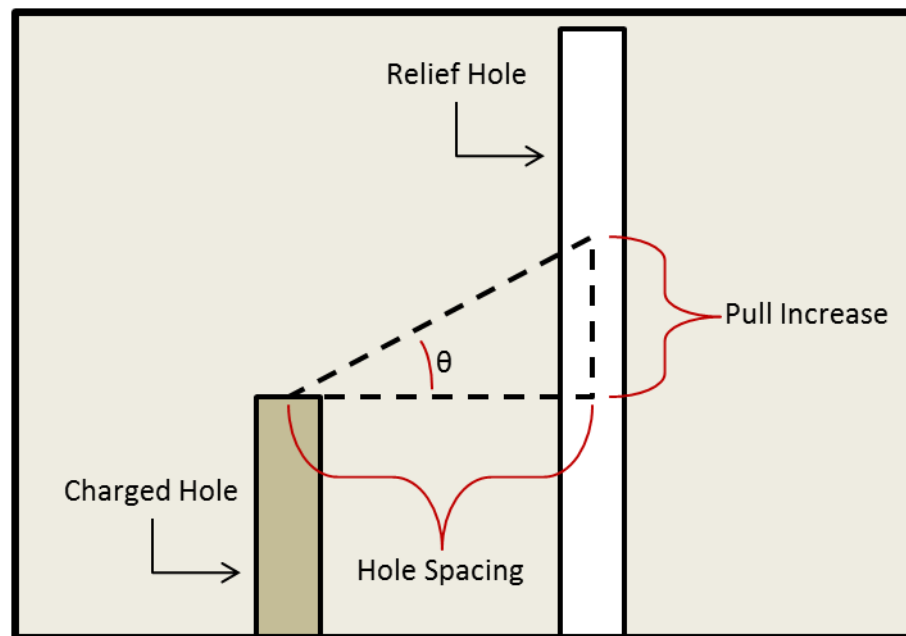

Figure 5.3. Extended Breakage Angle Diagram

$$\theta_E = \tan^{-1} \frac{\text{Pull Increase}}{\text{Hole Spacing}} \quad (8)$$

Table 5.6 shows that calculated angle of breakage for each extended round as well as the angle for the extended pull round average.

Table 5.6. Breakage Angles – Extended Pull Burn Cuts

Extended Breakage Angle - 6 and 5.5 Foot Reliever Holes			
Test Number	Hole Spacing (in.)	Increase (in.)	Breakage Angle (deg.)
Test 5	5	2.00	21.8
Test 8	5	3.88	37.8
Test 12	5	3.13	32.0
Test 13	5	3.06	31.5
Test 14	5	3.25	33.0
Test 15	5	1.06	12.0
Test 16	5	3.38	34.0
Test 17	5	1.88	20.6
Test 18	5	4.00	38.7
Test 19	5	2.06	22.4
Test 20	5	2.31	24.8
Test 21	5	3.63	35.9
Extended Cut Average	5	2.80	29.3

The author calculated the average angle of breakage from all twelve extended pull burns to be just under 30 degrees. This angle could prove critical in predicting what depths are obtainable based on the hole diameter utilized in the burn cut. Through further testing, research may prove that this angle will translate to greater pull depths when larger hole diameters are used. With the application of larger holes, the burden would also increase. If the 30 degree angle of breakage carries over, this larger burden would result in a greater extended pull. Table 5.7 illustrates the consequences of the introduction of larger hole diameters into the burn cut pattern, with the assumption that the 30 degree breakage angle applies.

Table 5.7. Hypothetical Extended Pull Results with Larger Hole Diameter  
(Applied to Cat-Hole Burn Design)

<b>Hypothetical Pull Increase - Assuming a 30 Degree Breakage Angle</b>			
Hole Diameter (in.)	Hole Burden (in.)	Breakage Angle (deg.)	Pull Increase (in.)
2	6.00	30	3.46
2.25	6.75	30	3.90
2.5	7.50	30	4.33

More research needs to be conducted in order to prove the breakage hypothesis. Although the assumption that the 30 degree angle of extended breakage is reasonable, the current results are not sufficient to prove conclusively that this angle can be applied in larger rounds. Further testing must also be done to see if this angle of breakage carries over to other burn cut designs and in other rock types.

After finding that a common average breakage angle was present in the extended burn cut rounds, the author examined the shortened rounds to see if a similar angle existed there as well. Figure 5.4 illustrates the angle of breakage concept as it applies to the shortened relief cuts, and Equation 9 shows how the reduced breakage angle was determined.

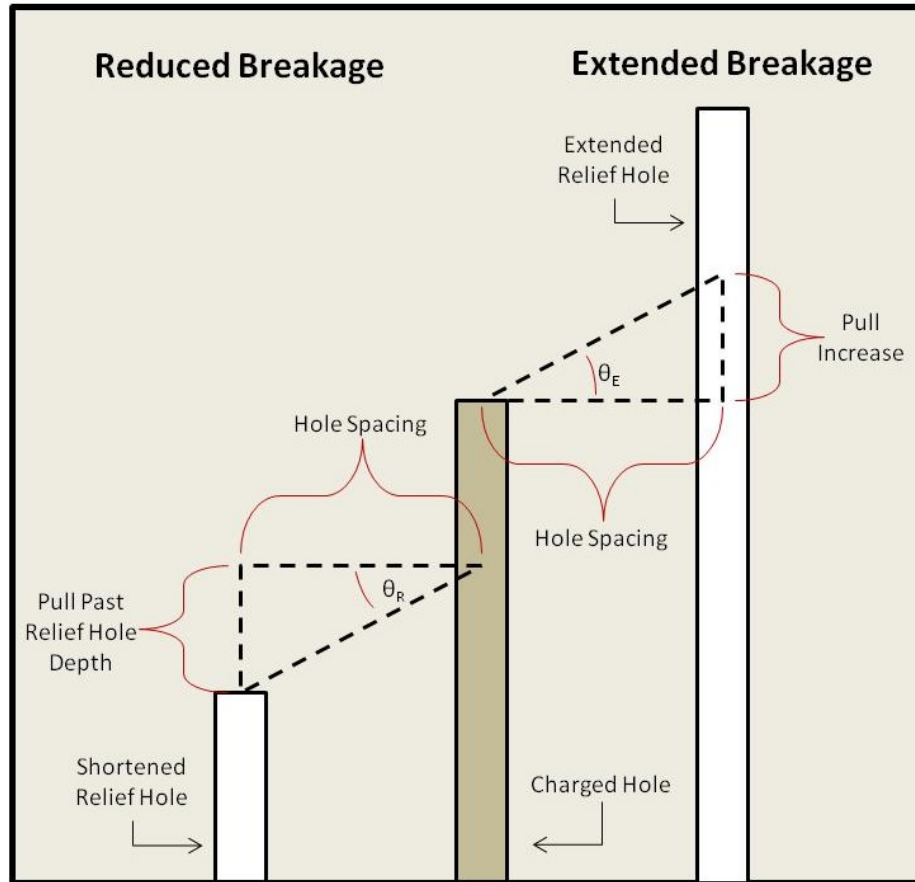

Figure 5.4. Breakage Angle Diagram

$$\theta_R = \tan^{-1} \frac{\text{Hole Spacing}}{\text{Pull Past Relief Hole Depth}} \quad (9)$$

When calculating the reduced breakage angle, the length of pull past the shortened relief hole depth is employed, rather than the increase in pull. With this equation the vertically opposite angle of breakage to the extended breakage angle is determined. Both angles originate from the loaded hole, just in the opposite direction. Using the modified equation, the average breakage angles for the shortened relief hole cuts were calculated. Table 5.8 depicts the determined angles.

Table 5.8. Breakage Angles – Reduced Pull Burn Cuts

Shortened Breakage Angle 4 and 4.5 Foot Reliever Holes			
Test Number	Hole Spacing (in.)	Pull Past Relief Hole (in.)	Breakage Angle (deg.)
Test 4	5	5.1	44.4
Test 6	5	5.8	40.8
Test 9	5	4.6	47.4
Test 11	5	6.4	38.0
Test 22	5	9.4	28.0
Test 23	5	6	39.8
Shortened Cut Average	5	6.2	39.7

The average angle of breakage on the shortened relief hole burn cuts was calculated at just under 40 degrees. This angle is 10 degrees lower than the angle found in the extended round tests. All of the angles determined from the extended, shortened, and baseline tests are plotted below, in Figure 5.5.

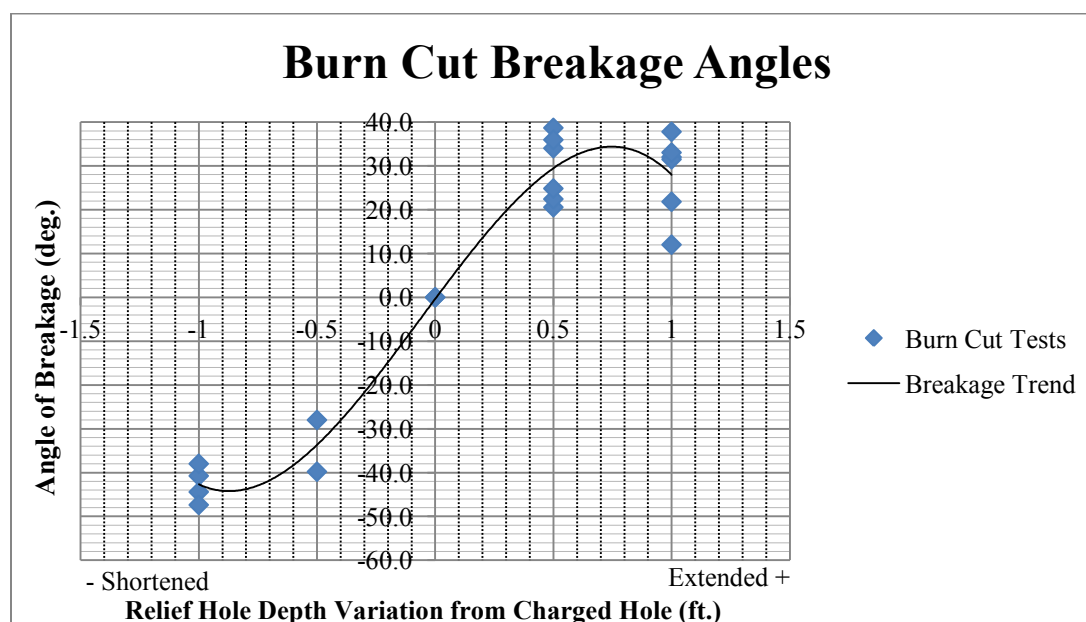

Figure 5.5. Breakage Angles - All Test Variations

In examining the plotted breakage angles, a trend in the data can be observed. Although, the trend line plotted in the figure shows the extended angle of breakage curving back towards the x-axis, logic would suggest that the angle will plateau out, holding near the maximum values displayed. Further testing at relief hole length variations between  $\pm 6$  inches from charged hole length must be completed in order to see if the trend seen in this data accurately predicts actual results at these depths.

### **5.5. DELAY TIMING VARIATION**

As previously mentioned, the nominal delay times in each of the twenty test rounds remained constant throughout testing, but the author varied the direction in which those times were assigned to progress around the pattern. This variation was added to the testing process in order to examine the effects, if any, that timing locations would have on each round's pull. Test results showed no direct link could be established between the timing order and the success of the round. Assigning a round's top holes to fire on the lower delay end of the spiral and the bottom holes to fire on the higher end caused no greater pull than the opposite. That being said, the order could have a dramatic effect on the resulting cut profile, depending on the length of the relief holes being tested.

In examining the profile results of shortened relief hole burn cuts, it was found that the hole fired on the highest delay was typically identifiable just by a look at the cut's subsequent profile. On average, the highest delayed hole (the last hole to fire) in the shortened rounds, successfully achieved a 5.44 inch greater pull than the rest of the round. Additionally, in both of the 4.5 foot rounds and two out of the four 4 foot rounds, the highest delayed hole region of the cut achieved a 5 foot, 100 percent pull. The likely cause of this deeper pull is the increased relief that the last hole to fire obtains through the first 100 milliseconds of the blast. The firing of the four prior holes leaves the last hole with the largest amount of relief of any of the holes. Figure 5.6 illustrates the breakage each hole will theoretically produce, based on the relief present.

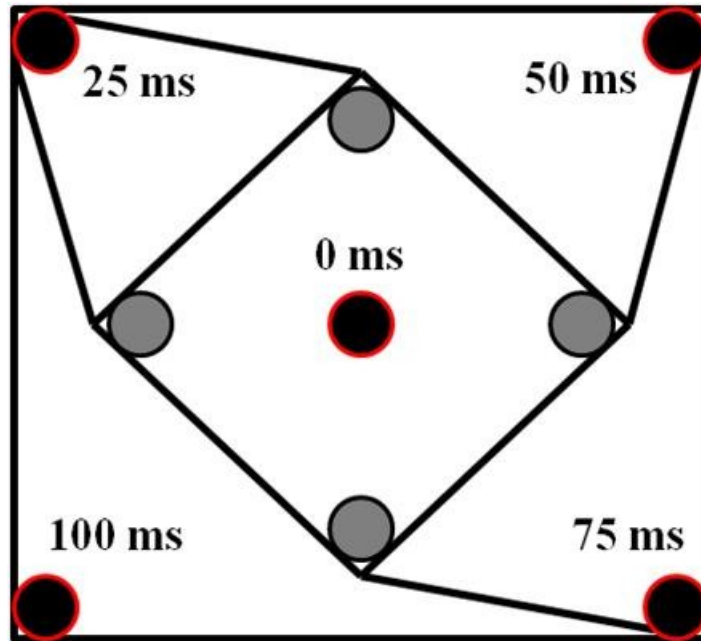

Figure 5.6. Breakage Zone Diagram  
(The 100 millisecond hole has the largest relief of any of the five charged holes, both in volume and in free face surface area.)

In contrast to the shortened relief hole burns, the extended hole cut profiles proved to be less influenced by the location of the highest delayed hole and more influenced by the presence of the extended relief holes. After completing an analysis of the cuts' pull averages by delay region, the determination was a greater pull length was not more likely in any specific region of the cut. Therefore, the delay progression utilized in the testing process had no effect on the outcome of the overall pull results for the extended length burn cuts. Notwithstanding, if, in the case of either the extended or shortened rounds, the delays had not all been assigned in a spiraling progression from the center of the hole, varied results would be expected. If, for example, the scanner operator assigned the 25 millisecond delay to the top right hole and then jumped to the bottom left (diagonally opposite) in order to assign the 50 millisecond hole, the results may have turned out differently. It was for this reason that the spiral timing pattern was selected, so that every round would be theoretically identical in the way the rock blast progressed.

## 5.6. REVERSE PRIMING

During the literature review phase of this project, this author encountered previous work that implied the application of reverse priming could be beneficial in cat-hole rounds [2]. In order to examine if the suggestion held merit for purposes of advanced pull, a decision was made to reverse prime the 0 millisecond hole in two of the six rounds, in order to observe whether it would have an effect on the resulting pull. With only a small quantity of reverse primed tests completed, the intent was not to prove the effects, positive or negative. Instead it was simply to see whether the test's variation warranted further research on the subject. Section 4.3.4 shows that the two tests employing the reverse priming method did indeed pull a depth farther than the other 5.5 foot rounds tested. However, the difference in pull was not large enough to definitively suggest that the reverse priming increased the rounds pull. Additionally, one round from the 6 foot extended round testing pulled further than one of the reverse primed tests results. This author feels that the results of these tests do warrant further testing into the matter of reverse priming the initial hole in the burn cut.



## 6. CONCLUSIONS

The analysis of the effects of varying the depth of the relief holes, while maintaining constant charged hole length and charge weight in a burn cut, arrives at two conclusions on the optimization of the round's pull. The two conclusions drawn are that shortening the length of relief hole results in a decrease in pull, whereas extending the length of the relief holes can result in an increase in pull beyond the charged hole length. The analysis also determined that several other factors must be researched further in order to fully optimize the burn cut's pull in relation to the varying of the uncharged relief hole length.

Through the testing of the shortened 4 foot and 4.5 foot relief hole pattern designs, the author determined that subtracting length from the relief holes in the burn cut, in comparison to the charged hole length, adversely affects the overall pull of the cut. By decreasing the relief hole length, the charged holes lose the relief required to break to their normal baseline length. The charged holes crater towards the opening of the cut, rather than breaking towards the center of the cut, as the pattern design intends. This cratering results in a poor cut profile. The lack of needed relief in the round also causes a freezing effect in the cut. The blast does not fully expel the broken material from the hole as it typically would, but instead each charged hole plastically deforms some of the material located at the back of the cut, leaving an increased burden for subsequent holes. The shortened relief hole designs are not economical, because of reducing pull, while keeping the same explosive costs and only insignificantly decreasing drilling costs.

Alternately, the extended 5.5 and 6 foot relief hole burn cut pattern designs establish that lengthening the relief hole length to longer than that of the charged hole depth benefits the cut's pull. These findings not only confirm what previous work states on the benefits of drilling extended relief holes, but also show that an increase in relief hole length enables the round in question to pull further than its 5 foot baseline counterpart. The additional hole length provides more relief in the back of the cut, allowing the explosives to break backwards, when normally only forward or horizontal breakage would be obtainable.

Both the 5.5 and 6 foot rounds achieved very similar average pull values. Surpassing the baseline test results of 5 feet by 2.88 inches and 2.73 inches, respectively, each round attained a pull percentage increase of just under 5 percent. Due to the tight margin in pull difference in two rounds with varying relief hole depths, the author determines an average of 3 inches is this cut's maximum attainable pull increase without changing other aspects of the pattern, such as hole diameter. Although the average pull of the rounds in testing was found to be slightly under 3 inches, for the application of these conclusions in an industry setting, the author suggests an extended hole length no less than 4 inches when utilizing a  $1\frac{5}{8}$  inch borehole. The extra depth accounts for rounds that attain a pull greater than 3 inches, examples of which were witnessed during testing.

With such a small increase in drilling depth making a sizeable pull difference, methods that are easy and economical must be found to gain that added borehole length. With blasting operations typically drilling to the limits of their drilling equipment and steel length, drilling an extra few inches in depth may not be so simple. However, one way that the author has considered to solve this dilemma is through a variation in drill bit design. If a modified drill bit were designed that was simply 4 inches longer in length (or whichever length an operation determines is their optimal relief hole depth increase) a quick bit swap would allow for the needed increased drill depth. This solution would be particularly applicable for operations that utilize burn cut designs that already employ larger diameter holes for their relief holes than in the rest of the round or employ a reamer bit to create a larger relief hole. In these cases, the driller is already switching drill bits in order to drill the rest of the round, so there is no change needed besides a modified bit length.

The 3 inches of additional pull may appear like an insignificant change in the results of a burn cut; however, the implications for blasting industry application quickly bring the benefits of even a small increase in pull into perspective. The 3 inches of added pull in the burn cut increases the relief that the remaining parts of the heading round will have through the rest of the blast. In small drift operations, this could result in advance increase as significant as 5 percent in every round. Additionally, with the main body of most heading rounds located outside of the burn, an additional 3 inches of the rock across

the entire round could be obtained. Helping to eliminate bootleg and attain maximum pull out of the entire round, the small extension in burn cut pull could produce a sizeable volume of rock. In cases where the rock is being excavated for sale, any increase in production while maintaining almost identical costs is very beneficial. The larger the heading, the larger the gains become.

The extended round testing also introduced a hypothesis concerning the angle at which the breakage occurs past the length of the charged holes. From examination of the data produced by this project, the author hypothesizes that rock breaks on average at a 30 degree angle backwards from the charged hole, towards the relief holes. The author determined the angle to be present in the extended burn cut tests throughout the project, but there is no data relating to whether this angle is present in larger diameter hole rounds of similar design and in burn rounds of varying design. The hypothesis justifies further testing into both of the design variations mentioned previously.

The burn cut analysis also concluded that adjusting the direction that the nominal delay timing spirals outwards from the center hole around the burn pattern has no observable effect on the overall resulting pull of the round. In the shortened relief hole tests, the author noted the highest delayed hole typically pulled the farthest, often to full depth. However, the location in which this delay or any of the other three preceding delays was placed neither increased nor decreased the pull of the round. Similarly, in the extended relief hole rounds, the delay sequence had no discernible effect on the outcome of the round.

Furthermore, the analysis arrived at no definitive conclusions on the reverse primed starter hole pattern variation. Although, the two rounds that received the reverse primed 0 millisecond delay hole resulted in a marginally greater pull than their standard 5.5 foot counterparts, not enough data was collected in order to evaluate the results effectively. The area requires further testing and evaluation before a decision can be made concerning its value to the burn cut design in question.

As a final point, this project arrived at several conclusions that represent a step forward in burn cut pull optimization. Proving that greater pull depths are achievable with the application of no additional explosives has beneficial implications for

underground blasting operations. The utilization of concepts proven successful within this project could reduce wasteful occurrences such as poor advance and bootleg, thus increasing production and reducing costs in underground heading blasting.

## 7. FURTHER WORK

Research into the area of burn cut pull optimization through the varying of relief hole depths also brought about further questions and presented more avenues for research in order to better understand the topic. Some of the questions raised fall directly in line with the work done in this project, while others branch into neighboring areas, which still have the potential to effect the conclusions presented previously. Here are the areas that this author believes could benefit from further research and definitely warrant a deeper investigation.

The first step that must be done in order to support and fully verify the conclusions drawn from the project is to move to full scale heading testing. Because test locations did not permit the testing of full length burn cuts and complete heading shots, further work is essential. Burn cut rounds need to be drilled and shot to a length comparable to real world applications to ensure that the results the author found transfer to full depth rounds. Similarly, the proceeding squares in the burn design and remaining bulk of the heading must be tested to make certain the extended cut pull aids in the reduction of bootleg throughout the entire round and allows for possible extended breakage across the rest of the face. The added relief from the deeper burn must transfer effectively across the rest of the round in order to truly be beneficial. One additional form of testing that could be completed in order to verify that an increased burn pull depth will benefit the rest of the round would be to drill and load the entire burn round to 1 foot deeper than the rest of the heading. Shooting the entire heading with this guaranteed extra foot of burn cut depth at the back of the round will clearly identify whether the rest of the round pulls more effectively with the additional relief.

Additional work should also be conducted to extend testing to different rock types and different hole diameters. The results of this research project prove that an increase in pull is achievable through the extension of the pattern's relief holes past the charged hole length, but how will the results respond when variables are changed. Tests need to be conducted in rock types of varying strengths as well as varying degrees of brittleness in order to determine how each will respond. Further research may prove that

changing certain rock conditions may improve results while changing others worsen the results. In fact, all variations in rock properties could have an effect on the burn cut and need to be examined further. Similarly, what will be the effect on an extended relief pattern when the borehole diameter is changed? As mentioned in Section 5.4, although the author observed a 30 degree angle of extended breakage at the back of the round, the question must be raised whether this angle will remain constant as the hole diameter and thus burden increases. One would expect geometric scaling to occur with these increases within the same rock type and geologic conditions. More tests must be completed at larger diameters in order to prove the 30 degree angle hypothesis. Until these areas are looked into, no inclusive conclusions can be made on the matter.

An additional area of research that this project examined briefly and determined warrants deeper investigation is the reverse priming of the first hole in the blast. Some work has been done on the matter in the past in relation to standard round designs, but the application of reverse priming might be even better suited for application with an extended relief hole design. Although not enough data was collected to arrive at a definitive answer as to whether reverse priming allowed the test rounds to pull deeper than their standard primed counterparts, the data looked promising. Reverse priming, whether in conjunction with application of extended relief hole burns or standard rounds, definitely needs to be investigated further. Furthermore, the possibility of other alternative priming locations needs to be examined as well. Tests varying the location of the primer throughout the charged hole may uncover an optimal location for powder column initiation in burn cuts that previously has not been considered.

In hindsight, this author also identified several aspects of the testing process that could be changed in order to increase the accuracy of the results obtained through this project. The first addition to the testing process that would be beneficial to data collection would be the introduction of a 3D scanner. By completing scans of the drift before and after each round is fired, a volumetric evaluation of each burn cut could be obtained. This data would give the author an additional way of verifying the pull of the round as well as examining the total rock excavated from the cut. Scanning or bore tracking technology could also be employed to measure the deviation present in the drill holes, subsequently allowing a researcher to see how deviation affects the data spread in

the pull analysis. A second change that could be made in the testing process would be to increase the diameter of the drill steel from  $\frac{7}{8}$  inch to 1 inch. This change, which would have to be completed on the jackleg itself as well, would reduce deviation in the drilling of the burn cuts. Finally, increasing the number of rounds tested would benefit the project. Additional data points would allow for more precise conclusions in the area of extended pull. This author recommends that further testing be completed on the extended relief hole rounds. Examining more depths between 0 feet and 1 foot deeper than the charged holes, as well as depths greater than 1 foot deeper, would help support the findings of this project. Advancing hole depth in small incremental steps would allow for more clarity in determining precisely how variable pull relates to extended relief hole length. Further knowledge in this area would allow researchers to find the optimum extended relief hole length for the burn cut.

**APPENDIX A.**  
**DRILLING TEMPLATE AND SPLIT COLLET DESIGNS**



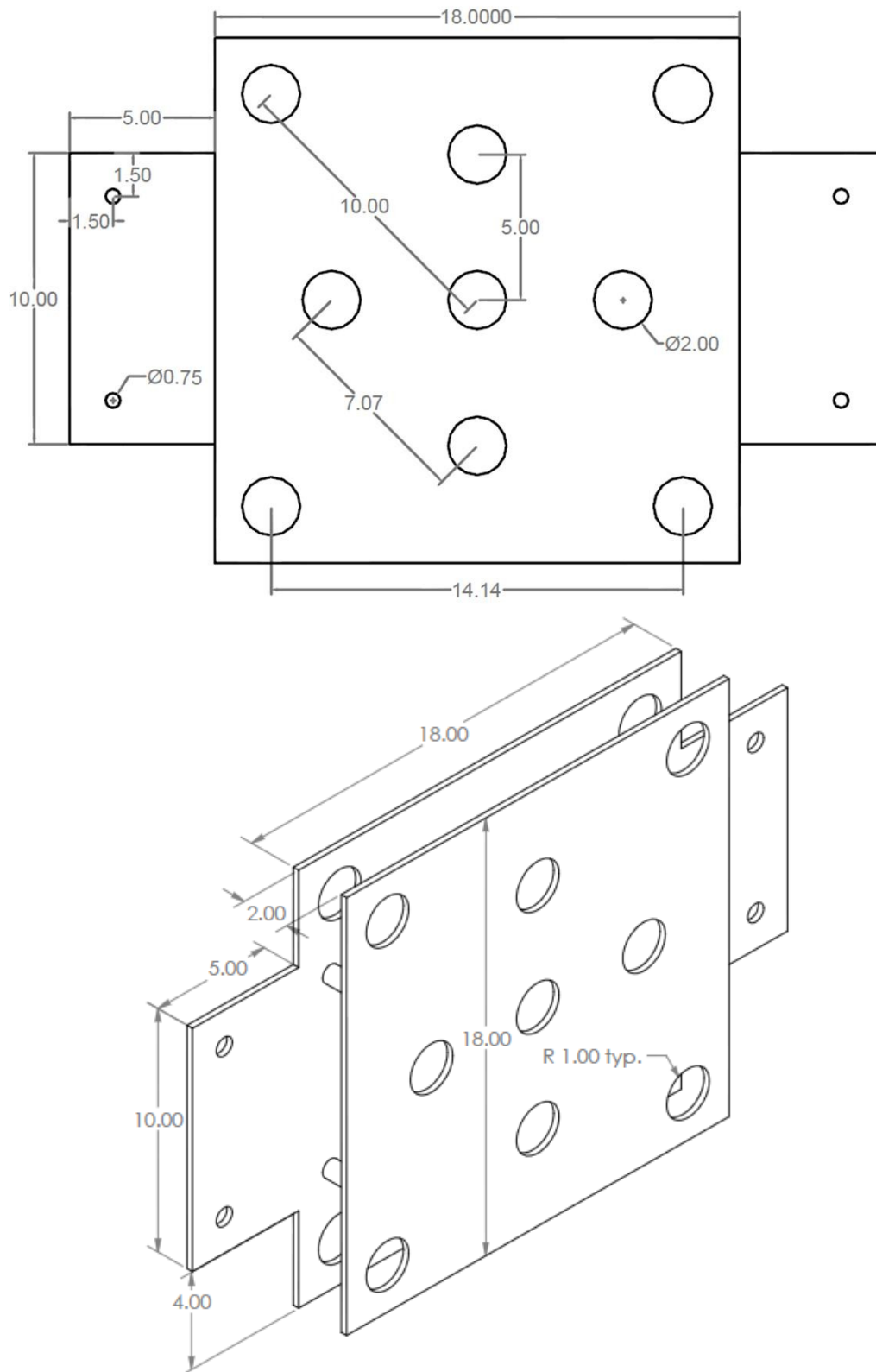

\*This diagram shows the design specifications for the drilling template.

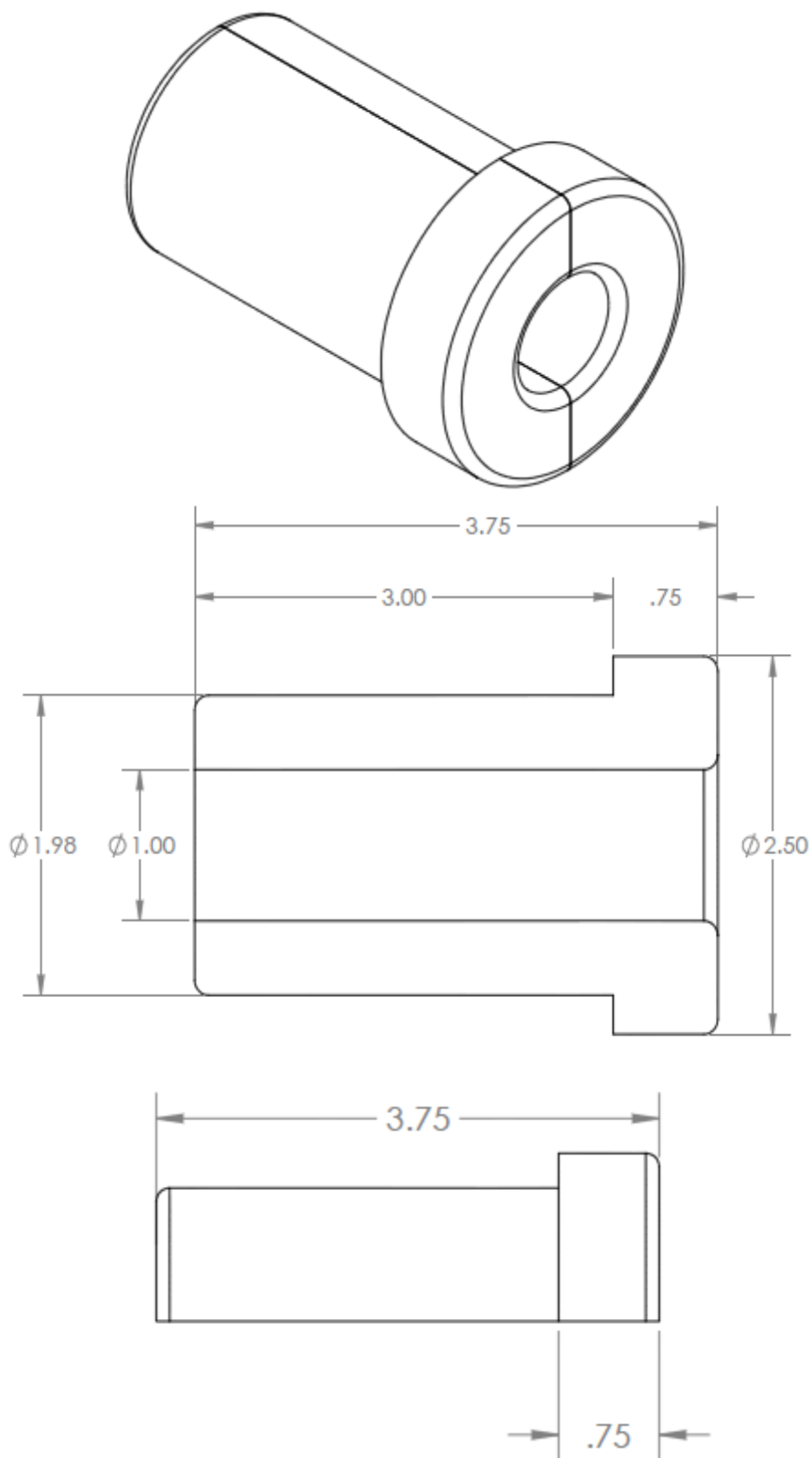

\*This diagram shows a detailed design schematic of the split collet.

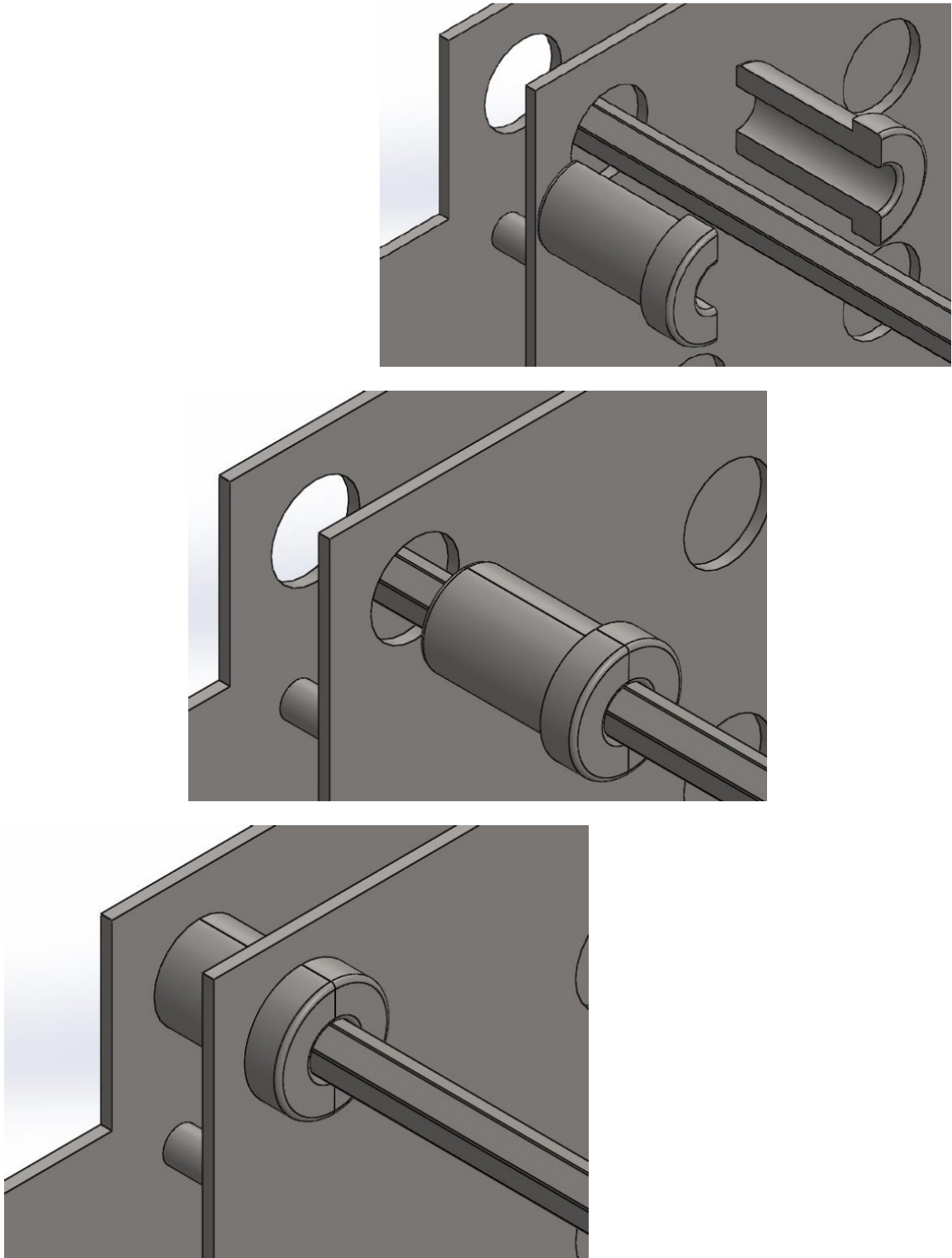

\*This diagram illustrates how the split collet is utilized in conjunction with the drilling template.

**APPENDIX B.**  
**EXPLOSIVES TECHNICAL DATA SHEETS**

# UNIMAX®

## Extra Gelatin Nitroglycerin Dynamite



### Product Description

UNIMAX is an extra gelatin dynamite formulated to consistently deliver high detonation velocity and excellent water resistance. UNIMAX is designed to satisfy the vast majority of explosive applications in hard rock and may be used as the main explosive charge where high density and energy is required or as a primer for ANFO.

### Application Recommendations

- UNIMAX is an excellent primer for Dynamix (ANFO), Dynamix-WR (WR ANFO) or other detonator sensitive packaged product and can be used as a secondary primer in hard seams or at the top of the explosive column.
- Minimum diameter is 25 mm (1 in).
- Minimum detonator is No. 8 strength.
- Storage at elevated temperatures and/or high humidity for 1 to 6 months can reduce the performance of Unimax depending on the diameter. Consult your Dyno Nobel representative for specific recommendations.
- Dynamites are susceptible to sympathetic detonation when applied in very wet conditions where boreholes are closely spaced and/or where geological conditions promote this effect. Consult your Dyno Nobel representative for recommendations where these conditions exist.

## Technical Information



### Properties

MSDS  
#1019

Density (g/cc) Avg	1.51
Energy <sup>a</sup> (cal/g)	1,055
(cal/cc)	1,510
Relative Weight Strength <sup>a</sup>	1.20
Relative Bulk Strength <sup>a,b</sup>	2.10
Velocity <sup>a</sup> (m/s)	5,300
(ft/s)	17,400
Detonation Pressure <sup>a</sup> (Kbars)	108
Gas Volume <sup>a</sup> (moles/kg)	32
Water Resistance	Excellent
Fume Class	IME1 & NRCan1 <sup>d</sup>

<sup>a</sup> All Dyno Nobel Inc. energy and gas volume values are calculated using PRODET™ the computer code developed by Dyno Nobel Inc. for its exclusive use. Other computer codes may give different values.

<sup>b</sup> ANFO = 1.00 @ 0.82 g/cc

<sup>c</sup> Unconfined @ 50 mm (2 in) diameter.

<sup>d</sup> Approved by Natural Resources Canada as Fume Class 1.

### Hazardous Shipping Description

Explosive, Blasting, Type A, 1.1D, UN 0081 II



D-07-05-11-12

See Product Disclaimer on page 2

**DYNO**  
Dyno Nobel

Groundbreaking Performance®

# UNIMAX®

## Technical Information



### Transportation, Storage and Handling

- UNIMAX must be transported, stored, handled and used in conformity with all applicable federal, state, provincial and local laws and regulations.
- For maximum shelf-life, dynamite must be stored in cool, dry and well-ventilated magazines. Dynamite inventory should always be rotated by using the oldest materials first. For recommended good practices in transporting, storing, handling and using this product, see the booklet "Prevention of Accidents in the Use of Explosive Materials" packed inside each case and the Safety Library Publications of the Institute of Makers of Explosives.

Diameter x Length		Quantity / Case	Case Type	Nominal Case Weight	
mm	in			kg	lbs
25 x 200	1 x 8	140	DA	20.4	44.8
32 x 200	1 1/4 x 8	88	DA	20.0	44.0
32 x 400	1 1/4 x 16	44	DA	20.0	44.0
40 x 200	1 1/2 x 8	60	DA	19.4	42.6
40 x 400	1 1/2 x 16	30	DA	20.5	45.0
50 x 200	2 x 8	34	DB	19.3	42.5
50 x 400*	2 x 16*	17	DB	19.3	42.5
60 x 400*	2 1/4 x 16*	13	DA	18.1	39.8
65 x 400*	2 1/2 x 16*	10	DB	18.6	41.0
75 x 200	3 x 8	16	DE	19.9	43.7
75 x 400*	3 x 16*	8	DE	20.4	44.8

- \* Available in spiral tube shell with tapered end.
- Note: all weights are approximate.
- Product density is 1.50 g/cc for package diameters less than 50 mm (2 in). Use cartridge count to determine actual explosive charge weight.
- UNIMAX is available in a wide variety of sizes. Custom sizes are subject to surcharge and may require longer than usual lead times.

\*\*Available upon request. Check with your Dyno Nobel representative should you have any questions.

### Case Dimensions

DA	45 x 34 x 17 cm	17 1/4 x 13 3/4 x 6 3/4 in
DB	45 x 34 x 15 cm	17 1/4 x 13 3/4 x 5 3/4 in
DE	45 X 34 X 17 cm	17 1/4 x 13 3/4 x 6 3/4 in

**Product Disclaimer** Dyno Nobel Inc. and its subsidiaries disclaim any warranties with respect to this product, the safety or suitability thereof, or the results to be obtained, whether express or implied, INCLUDING WITHOUT LIMITATION, ANY IMPLIED WARRANTY OF MERCHANTABILITY OR FITNESS FOR A PARTICULAR PURPOSE AND/OR OTHER WARRANTY. Buyers and users assume all risk, responsibility and liability whatsoever from any and all injuries (including death), losses, or damages to persons or property arising from the use of this product. Under no circumstances shall Dyno Nobel Inc. or any of its subsidiaries be liable for special, consequential or incidental damages or for anticipated loss of profits.

Dyno Nobel Inc.  
2795 East Cottonwood Parkway, Suite 500, Salt Lake City, Utah 84121 USA  
Phone 800-732-7534 Fax 801-328-6452 Web www.dynonobel.com

**DYNO**  
Dyno Nobel  
Groundbreaking Performance®

# POWERMITE®

## Small Diameter Detonator Sensitive Emulsion



### Product Description

POWERMITE and POWERMITE PLUS are detonator sensitive, high energy, water resistant, packaged emulsion explosives that are recommended for most underground drifting, quarry and construction blasting applications in medium rock types. POWERMITE and POWERMITE PLUS are also recommended when blasting where sulfide ore reactivity and/or sulfide ore dust explosion hazards exist.

### Application Recommendations

- Package diameter and type affect product density. Use cartridge count to determine actual explosive charge weight.
- At internal product temperatures higher than -18° C (0° F) ALWAYS use a Dyno Nobel high strength detonator or equivalent. At internal product temperatures below -18° C (0° F) and higher than -23° C (-10° F) use an 8 gm or larger case booster. For internal product temperatures below -23° C (-10° F) consult your Dyno Nobel representative for the recommended cast booster size.
- Use with detonating cord is not recommended.
- POWERMITE product are not recommended for use with pneumatic loading equipment. Severe impact may derade the emulsion quality and performance.
- Emulsion explosives are susceptible to "dynamic shock" and may detonate at low order or fail completely when applied in very wet conditions, where explosive charges or decks are closely spaced and/or where geological conditions promote this effect. Consult your Dyno Nobel representative for alternate product recommendations when these conditions exist.

## Technical Information



### Properties

MSDS  
#1030

	POWERMITE	POWERMITE PLUS
Density <sup>a</sup> (g/cc) Avg	1.15	1.15
Energy <sup>b</sup> (cal/g)	790	910
(cal/cc)	910	1,050
Relative Weight Strength <sup>b</sup>	0.90	1.03
Relative Bulk Strength <sup>b,c</sup>	1.26	1.45
Velocity <sup>d</sup> (m/s)	4,900	4,700
(ft/s)	16,100	15,400
Detonation Pressure <sup>e</sup> (Kbars)	69	63
Gas Volume <sup>e</sup> (moles/kg)	37	36
Fume Class		NRCan1*
Shelf Life Maximum	1 year (from date of production)	
Maximum Water Depth	30 m (100 ft)	
Water Resistance	Excellent	

<sup>a</sup> Product density without package.

<sup>b</sup> All Dyno Nobel Inc. energy and gas volume values are calculated using PRODET™ the computer code developed by Dyno Nobel Inc. for its exclusive use. Other computer codes may give different values.

<sup>c</sup> ANFO = 1.00 @ 0.82 g/cc.

<sup>d</sup> Unconfined @ 50 mm (2 in) diameter.

<sup>e</sup> Approved by Natural Resources Canada as Fume Class 1.

### Hazardous Shipping Description

Explosive, Blasting, Type E, 1.1D, UN 0241 II



P-02-05-05-14

See Product Disclaimer on page 2

**DYNO**  
Dyno Nobel

Groundbreaking Performance®

# POWERMITE®



## Transportation, Storage and Handling

- POWERMITE products must be transported, stored, handled and used in conformity with all applicable federal, state, provincial and local laws and regulations.
- Packaged emulsions have a shelf life of one (1) year when stored at temperatures between -18° C and 38° C (0° F and 100° F). Explosive inventory should be rotated. Avoid using new materials before the old. For recommended good practices in transporting, storing, handling and using this product, see the booklet "Prevention of Accidents in the Use of Explosive Materials" packed inside each case at the Safety Library Publications of the Institute of Makers of Explosives.

## Packaging = Paper

Diameter x Length		Case Quantity	Case Weight		Net Explosive Weight / Cartridge	
mm	in		kg	lb	kg	lb
32 x 200	1¼ x 8	109	18.2	40	0.17	0.37
32 x 300	1¼ x 12	70	18.2	40	0.26	0.57
32 x 400	1¼ x 16	57	18.2	40	0.32	0.71
38 x 300	1½ x 12	51	18.2	40	0.36	0.79
38 x 400	1½ x 16	38	18.2	40	0.48	1.06

## Packaging = Chub

Diameter x Length		Domestic (U.S.)	Plus	SL	Canada	Case Quantity	Case Weight		Net Explosive Weight / Cartridge	
mm	in						kg	lb	kg	lb
25 x 300	1 x 12	■		■		120	18.2	40	0.15	0.33
25 x 400	1 x 16			■		90	18.2	40	0.20	0.44
28 x 400	1¼ x 16		■			64	18.2	40	0.29	0.63
32 x 300	1¼ x 12	■				70	18.2	40	0.26	0.57
32 x 400	1¼ x 16		■	■		54	18.6	41	0.34	0.75
38 x 300	1½ x 12	■			■	50	18.6	41	0.37	0.81
38 x 400	1½ x 16	■		■		37	18.2	40	0.49	1.08
50 x 400	2 x 16	■			■	18	17.3	38	0.96	2.12
65 x 400	2½ x 16				■	12	17.7	39	1.47	3.24

## Packaging Details

- Package diameter and type affect product density. Use cartridge count to determine actual explosive charge weight. All weights are approximate.
- POWERMITE is available in a wide variety of sizes. Custom sizes are subject to surcharge and may require longer than usual lead times.
- Check with your Dyno Nobel representative should you have any questions.

## Case Dimensions

44 x 35 x 20 cm  
17.25 x 13.875 x 7.875 in

**Product Disclaimer** Dyno Nobel Inc. and its subsidiaries disclaim any warranties with respect to this product, the safety or suitability thereof, or the results to be obtained, whether express or implied, INCLUDING WITHOUT LIMITATION, ANY IMPLIED WARRANTY OF MERCHANTABILITY OR FITNESS FOR A PARTICULAR PURPOSE AND/OR OTHER WARRANTY. Buyers and users assume all risk, responsibility and liability whatsoever from any and all injuries (including death), losses, or damages to persons or property arising from the use of this product. Under no circumstances shall Dyno Nobel Inc. or any of its subsidiaries be liable for special, consequential or incidental damages or for anticipated loss of profits.

Dyno Nobel Inc.  
2795 East Cottonwood Parkway, Suite 500, Salt Lake City, Utah 84121 USA  
Phone 800-732-7334 Fax 801-328-6452 Web www.dynonobel.com

**DYNO**  
Dyna Nobel  
Groundbreaking Performance®



## Technical Data Sheet

**uni tronic™600 Electronic Detonator**The Power  
of Partnership**Description**

The *uni tronic™600* electronic detonator is one of Orica's exciting Next Generation products. The *uni tronic™600* detonator is used in conjunction with:

- Blast Box 310 (with Bluetooth) or 310R (with wireless Remote firing), both with new firmware
- Scanner 110 / 120 / 125 (with new firmware)
- Scanner 200 (with on-bench, full-function testing of detonators)
- *uni tronic™600* Tester for safe on-bench communication with Scanner 120 or 125 for testing of *uni tronic™600* detonators
- Duplex harness wire

**Applications**

*uni tronic™600* detonators can be used in most surface mining applications but are particularly suitable for small and medium opencast coal mines, quarry & underground aggregate industries, and for construction.

**Key Benefits**

- Reliable, effective and safe blasting is achieved because of the rugged, proven construction of the *uni tronic™600* detonator, with inherently safe testability on the blast pattern
- Efficient operations on the blast pattern are afforded by the convenient packaging and excellent, glove-friendly connector and duplex harness wire
- Predictable blasting results with minimal environmental impact are achievable because of the high precision of *uni tronic™600* electronic detonators
- Reliable initiation of all boosters is achieved by the full strength base charge in the detonator

**uni tronic™600**  
Electronic Blasting System

V1.6 Aug 2013

Page 1 of 3

**Properties**

Wire color	Yellow
Tensile strength (kg) / (lbs)	20 / 44
Explosives charge weight (mg)	900
Connector color	Red
Shell length x diameter	89 x 7.6 mm
Shell material	Copper alloy
Programmability (ms)	+ 1
Max delay time (seconds)	10
Precision as coefficient of variation	+/- 0.03%

**Available Lengths / Packaging**

*uni tronic™600* detonators are available in the following lengths and packaging:

Length m (ft) (configuration)	1.1B packaging		1.4S packaging	
	Units / Case	Weight per Case kg / lbs	Units / Case	Weight per Case kg / lbs
* 3 (10) coil	100	4.9 / 10.8	-	-
* 6 (20) coil	80	5.8 / 12.8	40	6.1 / 13.4
9 (30) coil	60	5.9 / 13.0	35	6.2 / 13.7
15 (50) spool	66	11.3 / 24.9	32	8.6 / 19.0
20 (65) spool	55	11.6 / 25.6	32	9.8 / 21.6
25 (80) spool	45	11.3 / 24.9	32	10.7 / 23.6
30 (100) spool	36	10.6 / 23.4	32	11.9 / 26.2
* 37 (120) spool	30	10.7 / 23.6	16	7.7 / 17.0
* 55 (180) spool	25	12.4 / 27.3	16	9.7 / 21.4

\*non-standard lengths requiring a longer lead time

**Recommendations for Use**

- *uni tronic™600* detonators can only be tested, programmed and fired using dedicated *uni tronic™* equipment. Do not use any other programming or blasting equipment.
- Damage to the legwire insulation is the most common cause of problems with electronic blasting systems; exercise care and protect the wires when loading and stemming holes



[www.oricamining.com](http://www.oricamining.com)

## Technical Data Sheet

The Power  
of Partnership**uni tronic™600 Electronic Detonator**

- The recommended operating temperature range of *uni tronic™600* detonators is -4°F (-20°C) to +149°F (+65°C).

**Product Classification**Authorised Name: *uni tronic™600*

Correct Shipping Name: Detonators, Electric for blasting

Hazard Class	1.1B	1.4S
UN Number	0030	0456
EX Number	EX2010060240	EX2010080322

All regulations pertaining to the handling and use of such explosives apply.

**Storage and Transport**

Store *uni tronic™600* detonators in a suitably licensed magazine for Class 1.1B explosives. The cases should be stacked in the manner designated on the cases.

*uni tronic™600* detonators have a storage life of up to 5 years in an approved magazine. The product is best stored at temperatures between -4°F (-20°C) to +120°F (+50°C). *uni tronic™600* detonators may be transported at temperatures between -40°F (-40°C) to +149°F (+65°C).

**Sleep-Time Within Boreholes**

The recommended maximum sleep time is 21 days. Sleep time is dependent on ground water conditions. An Orica Technical Services Representative should be consulted if special conditions exist that may reduce the allowed sleep time, or if sleep times longer than 21 days are needed.

**Disposal**

Disposal of explosive materials can be hazardous. Methods for safe disposal of explosives may vary depending on the user's situation. Please contact a local Orica representative for information on safe practices.

**Safety**

*uni tronic™600* electronic initiating systems provide a high level of safety against initiation by static electricity, stray electrical currents and radio frequency transmissions. However, these detonators contain pyrotechnics and

molecular explosives, which can initiate under intense impact, friction or heat.

As with all high explosives, *uni tronic™600* detonators must be handled and stored with care. These detonators may only be used at temperatures up to 70°C.

*uni tronic™600* detonators can only be tested, programmed and fired using dedicated *uni tronic™600* equipment. Do not use any other programming or blasting equipment.

See Safety Data Sheet for more information.

**Trademarks**

The word Orica, the Ring device and the Orica mark are trademarks of Orica Group Companies. *uni tronic™* is a trademark of Orica Explosives Technology Pty Ltd ACN 075 650 353, 1 Nicholson Street, East Melbourne, Victoria, Australia

**Disclaimer**

The information contained herein is based on experience and is believed to be accurate and up to date as at the date of its preparation. However, uses and conditions of use are not within the manufacturer's control and users should determine the suitability of such products and methods of use for their purposes. Neither the manufacturer nor the seller makes any warranty of any kind, express or implied, statutory or otherwise, except that the products described herein shall conform to the manufacturer's or seller's specifications. The manufacturer and the seller expressly disclaim all other warranties, INCLUDING, WITHOUT LIMITATION, WARRANTIES CONCERNING MERCHANTABILITY OR FITNESS FOR A PARTICULAR PURPOSE. Under no circumstances shall the manufacturer or the seller be liable for indirect, special, consequential, or incidental damages without limitation, damages for lost or anticipated profits.

**uni tronic™600**  
Electronic Blasting System

V1.6 Aug 2013

Page 2 of 3



[www.oricaminingservices.com](http://www.oricaminingservices.com)

Technical Data Sheet

## *uni tronic*<sup>TM</sup> 600 Electronic Detonator

The Power  
of Partnership



Orica Canada Inc.  
301 Hotel de Ville  
Brownsburg,  
QC J8G 3B5  
Tel: +1 303 268 5000  
Fax: +1 303 268 5250

Orica USA Inc.  
33101 East Quincy Ave  
Watkins, CO 80137  
Tel: +1 303 268 5000  
Fax: +1 303 268 5250

### Emergency Contact Telephone Numbers

For chemical emergencies (24 hour) involving transportation, spill, leak, release, fire or accidents:

Canada: Orica Canada emergency response 1-877-561-3636

USA: Chemtrec 1-800-424-9300

For lost, stolen or misplaced explosives:

USA: BATFE 1-800-800-3855. Form ATF F5400.0 must be completed and local authorities (state / municipal police, etc) must be advised.

**uni tronic 600**  
Electronic Blasting System

V1.6 Aug 2013

Page 3 of 3



[www.oricaminingservices.com](http://www.oricaminingservices.com)

**APPENDIX C.**  
**PHOTOGRAPHS OF BOOTLEG MEASURING DEVICE**

I. Measuring Pole



II. Extendable Measuring End



III. Readable Scale End



\*These photographs illustrate the method by which the measuring pole works. Photo I depicts the entire measuring pole. Photo II shows the extendable end of the pull, which is placed in the burn cut's bootlegs. Photo III portrays how the length of extension on the opposite end of the device can be easily read on the measurement scale. The photographs demonstrate how a bootleg of 1 foot in length would be measured and read on the scale.

**APPENDIX D.**

**4 FOOT - SHORTENED RELIEF ROUND DATA**

4 Foot Shortened Relief Tests												
Test 4			Test 6			Test 9			Test 11			
Delay Pattern	25 ms	50 ms	25 ms	50 ms	25 ms	100 ms	25 ms	100 ms	25 ms	100 ms	0 ms	
	100 ms	75 ms	100 ms	75 ms	50 ms	75 ms	50 ms	75 ms	50 ms	75 ms	0 ms	
Measured Pull (in.)	54	49	52	52	49	60	49	54	49	54	55	
	57.5	52.5	60	52	47	54	57	57	57	57	57	
Pull Average (in.)	53.10		53.80		52.60		54.40					



**APPENDIX E.**

**4.5 FOOT - SHORTENED RELIEF ROUND DATA**



		4.5 Foot Shortened Relief Tests			
		Test 22		Test 23	
Delay Pattern	25 ms	50 ms	25 ms	50 ms	
	0 ms		0 ms		
	100 ms	75 ms	100 ms	75 ms	
Measured Pull (in.)	54	55	54	48	
	58		54		
	60	60	60	54	
Pull Average (in.)	57.40		54.00		

**APPENDIX F.**  
**6 FOOT - EXTENDED RELIEF ROUND DATA**

6 Foot Extended Relief Hole Tests							
	5	8	12	13	14	15	
Delay Pattern	25 ms 0 ms 100 ms	50 ms 0 ms 75 ms	25 ms 0 ms 100 ms	50 ms 0 ms 75 ms	25 ms 0 ms 100 ms	50 ms 0 ms 75 ms	25 ms 0 ms 100 ms
Measured Pull (in.)	61 62.5 62.25	63.25 65 63.5	64.5 63.5 62.75	61.75 63 62.75	63.5 60 65.5	64 64 64	62 60.5 60.75
Pull Average (in.)	62	63.88	63.13	63.06	63.25	61.06	

**APPENDIX G.**

**5.5 FOOT - EXTENDED RELIEF ROUND DATA**

		5.5 Foot Extended Relief Hole Tests											
		16		17		18		19		20		21	
Delay Pattern	100 ms	25 ms	100 ms	25 ms	100 ms	25 ms	25 ms	50 ms	25 ms	50 ms	25 ms	50 ms	
	0 ms		0 ms		0 ms		0 ms		0 ms		0 ms		
	75 ms	50 ms	75 ms	50 ms	75 ms	50 ms	100 ms	75 ms	100 ms	75 ms	100 ms	75 ms	
Measured Pull (in.)	63	64.5	61.5	62	64	65	60.75	62.5	60.5	64	61	65.5	
	63	63	62	62	63	64	63.5	61.5	62.75	62	63.5	64.5	
Pull Average (in.)	63.38		61.88		64.00		62.06		62.31		63.63		

## BIBLIOGRAPHY

- [1] *ISEE Blasters' Handbook*. (18th ed.).(2011). International Society of Explosives Engineers, Cleveland, Ohio, Ch. 33 and 35, pp. 741, 843-870.
- [2] Langefors, U. and Kihlström, B. (1963). *The Modern Technique of Rock Blasting*, John Wiley & Sons, Inc., New York, USA, pp. 230-257.
- [3] Bullock, R.L. and Rostami, J. "Tunneling and Underground Construction" Min 383 class notes, Missouri University of Science and Technology. Rolla, MO. 2013.
- [4] Fitzwilliam, J.B.H. "A Study of the Efficiency of Split –Second Delay Electric Blasting Caps in Underground Limestone Mining." Master's Thesis, Mining Engineering, University of Missouri, School of Mines and Metallurgy, 1950. pp. 15, 51-54.
- [5] Sharma, P.D. "Tunnel Blasting – Emulsion Explosives and Proper Blast Design are the Prerequisite for Better Efficiency", Indian Journal of Mines, Metals, and Fuel. 2005. pp 10.
- [6] Singh, S.P. "Suggestions for Successful Cut Blasting" Conference Paper. 21<sup>st</sup> Annual Conference on Explosives and Blasting Technique. International Society of Explosives Engineers. 1995.
- [7] Kuzyk, G.W., Onagi, D.P. and Mohanty, B. "Innovative Blasting Techniques for Excavating Long Tunnel Rounds". *Explosives and Blasting Technique*. Proceedings of European Federation of Explosive Engineers –Second World Conference on Explosives and Blasting Technique. 2003. pp. 173-179.
- [8] Kuzyk, G.W. and Martino, J.B. "URL Excavation Design, Construction and Performance". Project Report. Atomic Energy of Canada Limited. 2008. pp. 40-48.
- [9] Hagan, T.N. "Larger Diameter Blastholes – A Proposed Means of Increasing Advance Rates". Conference Paper. Fourth Australian Tunneling Conference. 1981.
- [10] Hagan, T.N. "Means of Increasing Advance Rates and Reducing Overall Costs in Drill-and –Blast Tunneling". Conference Paper. Fifth Australian Tunneling Conference. 1984.
- [11] Barkley, T.L. "A Long Round Test in Conventional Room and Pillar Mining" Conference Paper. 26<sup>th</sup> Annual Conference on Explosives and Blasting Technique. International Society of Explosives Engineers. 2000.

- [12] Barkley, T.L. “Measuring Underground Face Drilling and Blasting” Conference Paper. 29<sup>th</sup> Annual Conference on Explosives and Blasting Technique. International Society of Explosives Engineers. 2003.
- [13] Persson, P.A., Holmberg R. and Lee, J. (1994). *Rock Blasting and Explosives Engineering*. CRC Press, Inc., Boca Raton, Florida, pp. 217.
- [14] Singh, S.P. “Discussion on the Mechanics of Cut Pulling in Underground Mines” Research Paper. *Mine Planning and Equipment Selection '95*. 1995. pp. 235-241.
- [15] Worsey, P. “Advanced Blasting Design and Technology” Explosives 350 class notes, Missouri University of Science and Technology. Rolla, MO. 2013.
- [16] “UNIMAX Technical Information” Dyno Nobel. 19 May 2014. <[www.dynonobel.com](http://www.dynonobel.com)>.
- [17] “POWERMITE Technical Information” Dyno Nobel. 19 May 2014. <[www.dynonobel.com](http://www.dynonobel.com)>.
- [18] “uni tronic™ 600 Electronic Detonator Technical Data Sheet” Orica North America. 19 May 2014. <[www.oricaminingservices.com](http://www.oricaminingservices.com)>.
- [19] Dick, R.A., Fletcher, L.R., and D’Andrea, D.V. (1982). *Explosives and Blasting Procedures Manual*. US Department of the Interior, Bureau of Mines. Washington D.C., pp.46-47.
- [20] Olofsson, S.O. (1997). *Applied Explosives Technology for Construction and Mining*, APPLEX, Ärla, Sweden, pp. 138.

## VITA

Michael Robert Allen was born in St. Louis, Missouri. He started his University career at the Missouri University of Science and Technology in 2008. He received a Bachelor of Science in Mining Engineering with an emphasis in Explosives Engineering from the Missouri University of Science and Technology in May 2012, graduating with honors. After completing his undergraduate degree, he pursued a Master of Science in Explosives Engineering. While completing his graduate work, he worked as the graduate teaching assistant for both introductory and advanced level drilling and blasting classes. Michael received a Master of Science in Explosives Engineering from the Missouri University of Science and Technology in August 2014. Michael has mining industry experience in underground limestone, surface copper, and surface non-metal shot service. Michael is also a licensed blaster in the state of Missouri.

Michael Robert Allen has been a member of the International Society of Explosives Engineers (ISEE) since 2009, serving as the Missouri University of Science and Technology Chapter Vice-President in 2012. He remains an active member of the Society for Mining, Metallurgy, and Exploration since 2011. He is also a proud competitor in the International Intercollegiate Mining Competition, serving as Captain of the Missouri Men's Team from 2012 to 2014.

This is the first paper Michael Robert Allen has written to date.



